





Attrezzature professionali per posatori 

Professional tools for tile layers 

Herramientas profesionales para colocadores 

1946



Catalogo generale

General product portfolio

Catálogo general



LANGUAGES AVAILABLE: DE - FR

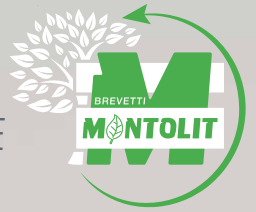

for EARTH and PEOPLE



Brevetti Montolit è nata nel 1946 dalle geniali intuizioni del Cav. Montoli Vincenzo e non si è più fermata; da allora l'evoluzione è stata incessante. Pilastrini portanti dalla nascita sono: propensione all'innovazione, creatività e continua voglia di migliorarsi indispensabili per generare prodotti unici coperti da brevetti internazionali.

Brevetti Montolit was conceived in 1946 by the brilliant mind of Vincenzo Montoli, and never stopped after that; since then, the evolution has been incessant. Since its foundation, its cornerstones have been: propensity for innovation, creativity, and continuous desire to improve, essential for generating unique products covered by international patents.

Brevetti Montolit nace en 1946 de las brillantes iniciativas de Vincenzo Montoli y desde entonces no se ha vuelto a detener, la evolución ha sido incesante. Los principales pilares desde su nacimiento han sido la propensión a la innovación, la creatividad y las continuas ganas de superación, indispensables para generar productos únicos amparados por patentes internacionales.

2023

1974

1946





IT NOVITA'
GB NEWS
ES NOVEDAD

pg. 02 > 03



IT Tagliapiastrelle manuali
GB Manual tile cutters
ES Cortadoras manuales de baldosas

pg. 04 > 15

Ricambi | Spare parts | Recambios

pg. 16 > 17

300 PROJECT 300

IT Tecnologie per la lavorazione delle lastre ceramiche
GB Technologies for processing ceramic slabs
ES Tecnologías para el procesamiento de losas cerámica

pg. 18 > 38



IT Movimentazione di grandi lastre
GB Handling system for slabs
ES Movilización de grande losas

pg. 20 > 27



IT Sistemi di taglio per il grande formato
GB Large format cutting systems
ES Sistemas de corte de gran formato

pg. 28 > 33



IT Ventose battenti per piastrelle e lastre
GB Thumping suction cups for tiles and slabs
ES Ventosas vibrante para baldosas y losas

pg. 34 > 35



IT Sistema di profilatura a secco
GB Dry profiling system
ES Sistema de perfilado en seco

pg. 36 > 38



IT Attrezzature elettriche
GB Electric equipment
ES Equipos electricos

pg. 39 > 45



IT Attrezzature manuali per la posa
GB Manual equipment for the laying of tiles
ES Equipos manuales para la instalación de baldosas

pg. 46 > 49



IT Tranciblocchetti / tagliategole
GB Paving block cutters / Roof tiles cutter
ES Cortadoras de bloques manual / Cortadora de tejas

pg. 50 > 51

Ricambi | Spare parts | Recambios

pg. 52 > 53



IT Lame circolari per legno
GB Circular blades for timber
ES Cuchillas circulares para madera

pg. 54



IT Guida assistita per tagli perfetti
GB Assisted guide for perfect cuts
ES Guía asistida para cortes perfectos

pg. 55



IT Utensili diamantati DNA
GB DNA diamond tool
ES Herramientas de diamantes DNA

pg. 56 > 68



IT Dischi diamantati
GB Diamond blades
ES Discos diamantados

pg. 70 > 84



IT Foratura
GB Drilling
ES Perforación

pg. 85 > 96



IT Lavorazioni speciali
GB Special works
ES Obras especiales

pg. 97 > 106



IT Espositori modulari
GB Assembling displays
ES Dispositivos modulares

pg. 107 > 108

Condizioni di vendita | Term of sales | Condiciones de venta

pg. 109

NUOVI prodotti

pg.
11

CARAPAX

- IT Protezione elastica per tagliapiastrelle **Masterpiuma P5**.
- GB Elastic protection for **Masterpiuma P5** tile cutters.
- ES Protección elástica para cortadoras de baldosas **Masterpiuma P5**.



P5-TOP

pg.
9

P5 131/161 + Carapax + Atlas

pg.
20

GECO ROBOT

- IT Sistema robotizzato a batteria per la movimentazione delle lastre.
- GB Battery powered robotic system for handling slabs.
- ES Sistema robótico a baterías para manipulación de losas.



pg.
24

SUPERLIFT e-power

- IT Sistema modulare di movimentazione lastre.
- GB Modular handling system for slabs.
- ES Sistema modular de movilización de losas.



NEW products

pg.
23

GECONE

- IT Ventosa super professionale a batteria.
- GB Super professional battery-powered suction cup.
- ES Ventosa super profesional a batería.



GECO
e-power

pg.
22

pg.
95

SDB JUNIOR

- IT Custodia protettiva per utensili diamantati.
- GB Safe little case for diamond tools.
- ES Caja para herramientas diamantadas.



pg.
88

FSBH Mondrillo **Black-H**

- IT Frese diamantate per foratura a secco.
- GB Diamond core-bits for dry drilling.
- ES Fresas diamantadas para perforación en seco.



pg.
89

FS-TI Mondrillo **Titanium Gold**

- IT Frese diamantate per foratura a secco.
- GB Diamond core-bits for dry drilling.
- ES Fresas diamantadas para perforación en seco.



pg.
102

STL Mondrillo

- IT Mole diamantate per taglio, levigatura e lavorazioni speciali.
- GB Diamond cup wheels for cutting, grinding and special processing.
- ES Muelas de diamante para el cortar, rectificar y procesamiento especiales.



pg.
75

JOLLYMONT

- IT Disco diamantato speciale per operazioni di taglio e Jolly.
- GB Diamond blade for cutting and Jolly operations.
- ES Disco de diamante especial para operaciones de corte y Jolly.



pg.
59

SCX-F

- IT DNA Sandwich per taglio preciso.
- GB DNA Sandwich for precise cutting.
- ES DNA Sandwich para corte preciso.



TC-HD

- IT Turbo sottile per porcellanato alta densità.
- GB Turbo thin for high density porcelain.
- ES Turbo fino para porcelánico de alta densidad.

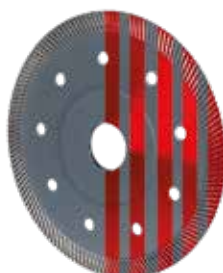

CPJ250

- IT Disco diamantato per taglio jolly ad umido.
- GB Diamond blade for wet jolly cutting.
- ES Disco diamantado para Jolly en húmedo.



P5 MASTERPIUMA **POWER**

Tagliapiastrelle manuali SUPER PROFESSIONALI
SUPER PROFESSIONAL manual tile cutters
Cortadoras manuales de baldosas SUPER PROFESIONAL

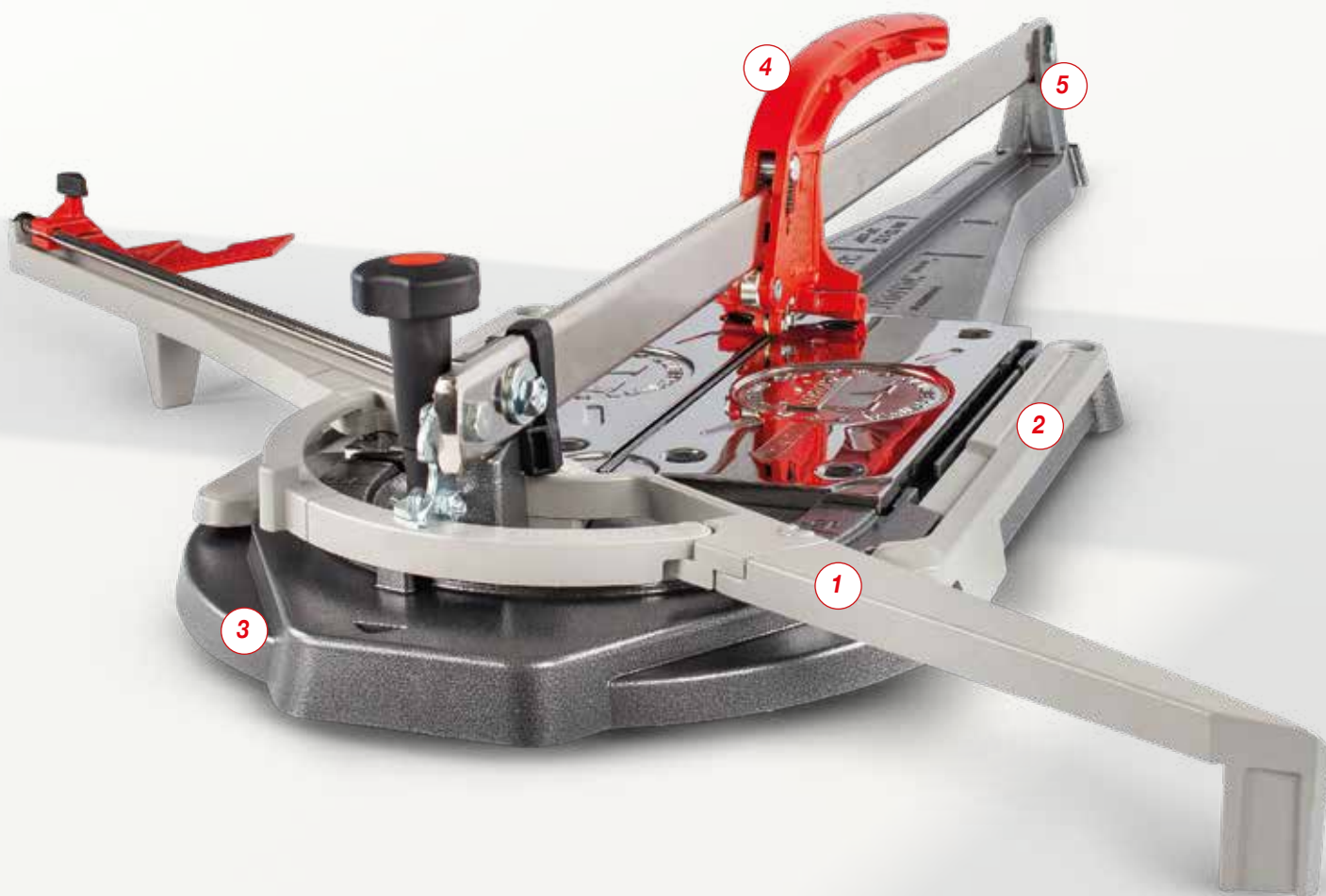

Play

5 punti importanti key features puntos importantes



1 Squadra multifunzione
Multi-functional square
Escuadra multifunción

2 Grandi supporti laterali in alluminio
Aluminium extra large supports
Soportes extra grandes de aluminio

3 Telaio modulare strutturato
Reinforced modular frame
Bastidor modular estructurado

4 Indicatori di forza
Strength indicators
Indicadores de fuerza

5 Progettata per grandi formati
Designed for large formats
Diseñada para grandes formatos





MASTERPIUMA



Supporti laterali in alluminio
Aluminium side supports
Soportes laterales en aluminio

F.A.Q.

IT Come posso supportare piastrelle di grande formato?

GB How do I support large format tiles?

ES ¿Cómo apoyo las baldosas de gran formato?



▶ Play



IT Perché la tagliapiastrelle Masterpiuma velocizza il processo di taglio ripetitivo?

GB Why does Masterpiuma tile cutter speed up the cutting process for repetitive cuts?

ES Por qué la cortadora Masterpiuma acelera el proceso de corte en cortes repetitivos?

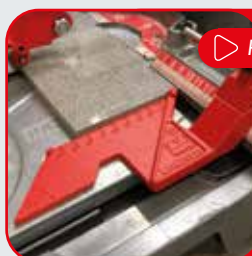

▶ Play



Incisione ergonomica a spinta con indicatori di forza
Ergonomic Push incision with strength indicators
Incisión ergonómica de empuje, con indicadores de fuerza

IT È possibile effettuare tagli laterali molto stretti su piastrelle in gres porcellanato di grande formato?

GB Is it possible to make very narrow side cuts on large format porcelain tiles?

ES ¿Es posible hacer cortes laterales muy estrechos en azulejos de gran formato?



▶ Play



IT È possibile tagliare la ceramica, il mosaico di vetro con questo tagliapiastrelle manuale? E che dire del mosaico in gres per piscine?

GB Is it possible to cut ceramic, glass mosaic with this manual tile cutter? And what's about gresite mosaic for swimming pools?

ES ¿Es posible cortar mosaico de cerámica, vidrio con este cortador manual de azulejos? ¿Y el mosaico de gresite para piscinas?



▶ Play



100% materiale riciclabile
100% recycled material
Material 100% reciclable

Piedoni antiscivolo
Non-slip feet
Pies antideslizantes

Telaio modulare strutturato
Reinforced modular frame
Bastidor modular estructurado



Squadra multifunzione con incisione laser
Multifunctional square with laser engraving
Escuadra multifuncional con grabado láser

Finecorsa elastico
Elastic stop
Parada elástica

Rotazione squadra $-45^\circ \div +45^\circ$
Square rotation $-45^\circ \div +45^\circ$
Rotación de equipo -45° a $+45^\circ$

Squadretta di riferimento ribaltabile
Folding measurement square
Soporte de referencia plegable

Incisione assistita (da 0 a 20mm)
Incision assistance (from 0 to 20 mm)
Incisión asistida (de 0 a 20 mm)



Piani in acciaio molleggiati
Spring metal support tables
Superficies de soporte en acero suspendido

Rotella di incisione a vista titanium gold con guida in acciaio inox
High visibility titanium wheel with stainless steel guide
Rueda de grabado alta visibilidad con guía de acero inoxidable

Lubrificazione integrata
Integrated lubrication
Lubricación integrada

Doppio sistema di spacco con mirino brevettato
Dual splitting device with patented viewfinder
Doble sistema de rotura con visor patentado



| | Art. |  | | 63P5 | 63P5XL | 75P5 | 93P5 | 131P5 | 161P5 |
|---|-------|---|--|------|--------|------|------|-------|-------|
|  | 245 | S/12 | | ✓ | ✓ | ✓ | ✓ | ✓ | ✓ |
|  TITANIUM | 245T | S/12 | | ✓ | ✓ | ✓ | ✓ | ✓ | ✓ |
|  | 505P5 | S/1 | | ✓ | ✓ | | | | |
| | 506P5 | S/1 | | | | ✓ | ✓ | ✓ | ✓ |
|  | 507 | B/1 | | ✓ | ✓ | ✓ | ✓ | ✓ | ✓ |
|  | 515-5 | B/1 | | ✓ | ✓ | ✓ | ✓ | ✓ | ✓ |
|  | 428P2 | S/1 | | ✓ | ✓ | ✓ | ✓ | ✓ | ✓ |
|  | 480P5 | B/1 | | ✓ | | | | | |
| | 481P5 | B/1 | | | ✓ | ✓ | ✓ | ✓ | ✓ |
|  | 456P5 | S/1 | | ✓ | ✓ | ✓ | ✓ | | |
| | 457P5 | S/1 | | | | | | ✓ | ✓ |
|  | 458P5 | S/1 | | ✓ | ✓ | ✓ | ✓ | | |
| | 459P5 | S/1 | | | | | | ✓ | ✓ |
|  | 418P5 | S/1 | | ✓ | | | | | |
| | 418P | S/1 | | | ✓ | ✓ | ✓ | ✓ | ✓ |
|  | 519P5 | S/1 | | ✓ | | | | | |
|  | 516P5 | S/1 | | | ✓ | ✓ | ✓ | ✓ | ✓ |
|  | 281 | S/1 | | ✓ | ✓ | ✓ | ✓ | | |
| | 281H | S/1 | | | | | | ✓ | ✓ |
|  | 440P2 | S/1 | | ✓ | ✓ | ✓ | ✓ | ✓ | ✓ |

Art. **63P5XL**  **63 cm (24,5 inch)**

| cm | inch | max cm | max inch | kg | C/1 |
|---------|---------|--------|----------|----|-----|
| 44 x 44 | 17 x 17 | 2 | 3/4 | 11 | C/1 |

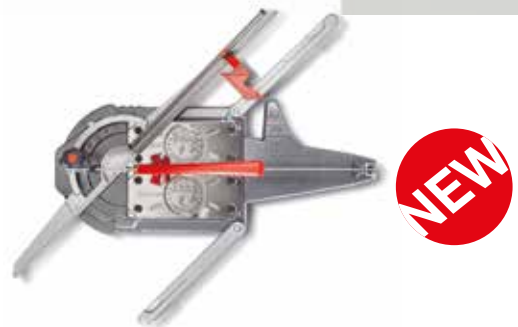

Art. **75P5**  **75 cm (29 inch)**

| cm | inch | max cm | max inch | kg | C/1 |
|---------|---------|--------|----------|----|-----|
| 53 x 53 | 21 x 21 | 2 | 3/4 | 14 | C/1 |

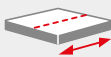

Art. **93P5**  **93 cm (36 inch)**

| cm | inch | max cm | max inch | kg | C/1 |
|---------|---------|--------|----------|----|-----|
| 66 x 66 | 26 x 26 | 2 | 3/4 | 15 | C/1 |

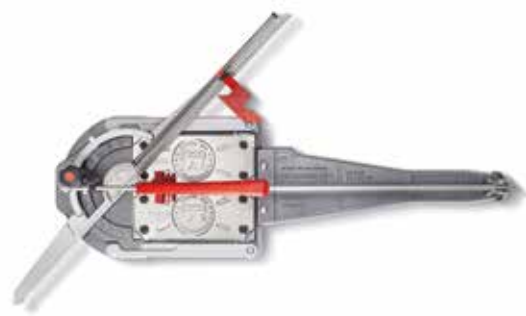

Art. **131P5**  **131 cm (51,5 inch)**

| cm | inch | max cm | max inch | kg | C/1 |
|---------|-------------|--------|----------|----|-----|
| 92 x 92 | 36,5 x 36,5 | 2 | 3/4 | 25 | C/1 |

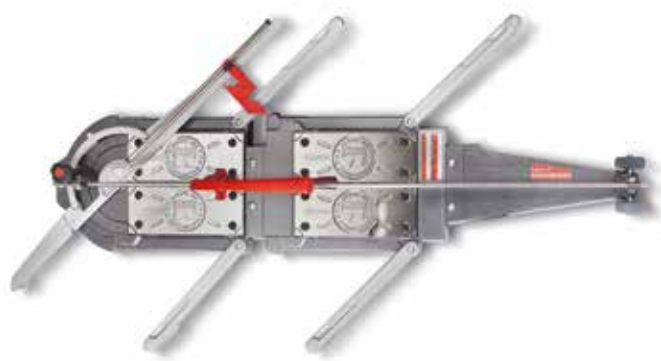

Art. **131P5-TOP**  

Include Carapax e Atlas - Carapax and Atlas included - Carapax y Atlas incluidos

Art. **161P5**  **161 cm (63,5 inch)**

| cm | inch | max cm | max inch | kg | C/1 |
|-----------|-------------|--------|----------|----|-----|
| 113 x 113 | 44,5 x 44,5 | 2 | 3/4 | 29 | C/1 |

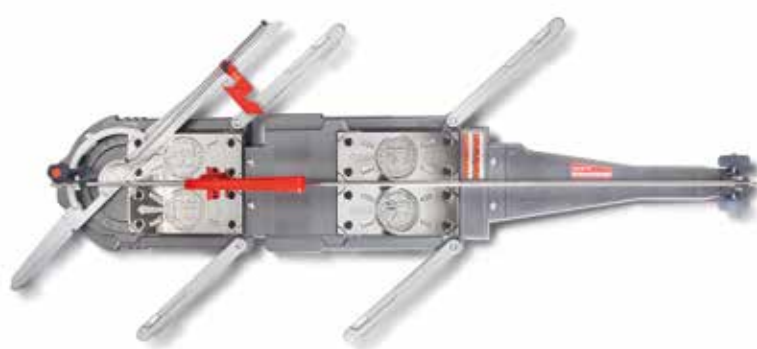

Art. **161P5-TOP**  

Include Carapax e Atlas - Carapax and Atlas included - Carapax y Atlas incluidos

*Mod. "inch" - Su richiesta - On request - A pedido

MOSAKIT

Art. 58

- IT Tappetino in gomma per mosaici, piastrelle in vetro, delicate e sottili (3mm).
- GB Rubber pad for mosaic tiles, delicate and very thin 3mm glass tiles.
- ES Alfombra de goma para mosaicos, baldosas de vidrio, delicadas y finas (3 mm).



BASEBOARD

Art. 64

- IT Riferimento aggiuntivo per grandi formati ideale per il taglio di listelli e di battiscopa.
- GB Bracket precision for cutting strip tiles and skirting boards.
- ES Referencia adicional para grandes formatos ideal para el corte de listones y zócalos.

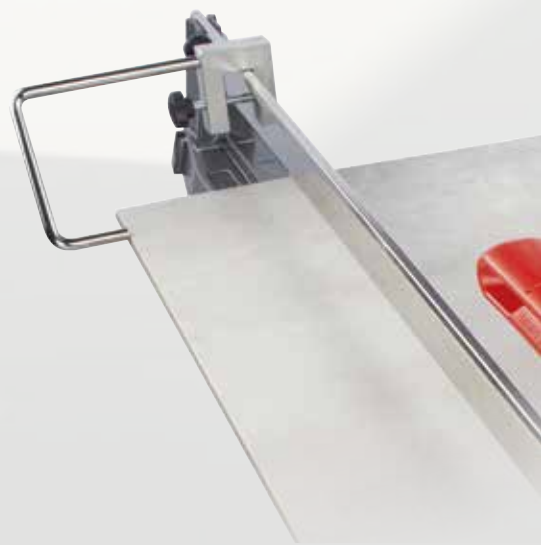
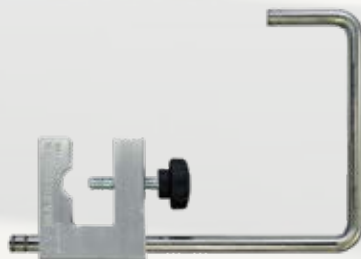

VERTIGO

Art. VERTIGO2

- IT Supporto per tagliapiastrelle manuali. Agevola il taglio in verticale delle piastrelle di grande formato.
- GB Support for manual tile cutter, Facilitates the vertical cutting of large format tiles.
- ES Soporte para cortador as de baldosas manuales, Facilita el corte en vertical de las baldosas de gran formato.

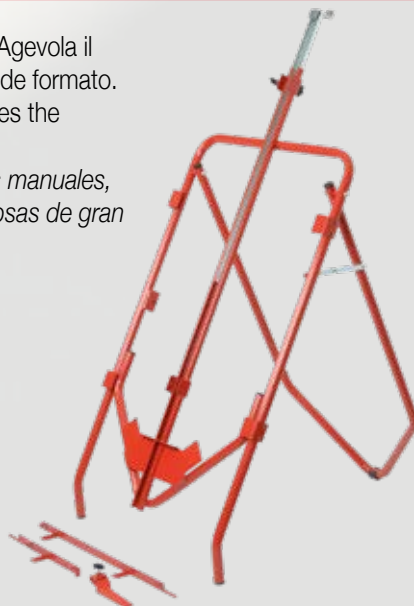
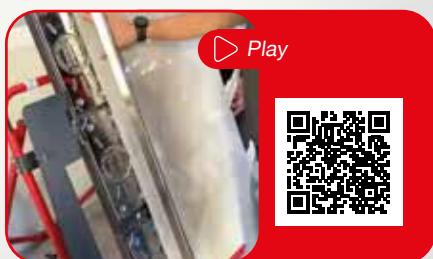

ATLAS



Art. ATLAS

- IT Sostegno elastico con doppia regolazione (altezza e peso) per piastrelle di grandi dimensioni utilizzabile con ogni tipo di tagliapiastrelle manuale.
- GB Elastic support with double adjustment (height and weight) for large tiles. Can be used with all types of professional manual tile cutters.
- ES Soporte elástico ajustable para baldosas grandes. Puede utilizarse con cualquier tipo de cortadora manual de baldosas.

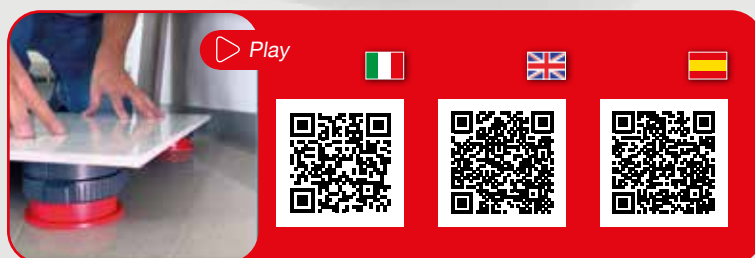

CARAPAX



Art. CARAPAX

- IT Protezione elastica per tagliapiastrelle **Masterpiuma P5**
- GB Elastic protection for **Masterpiuma P5** tile cutters.
- ES Protección elástica para cortadoras de baldosas **Masterpiuma P5**.



"Atlas" non inclusi
"Atlas" Not included
"Atlas" No incluido



MASTERPIUMA EVOLUTION 3

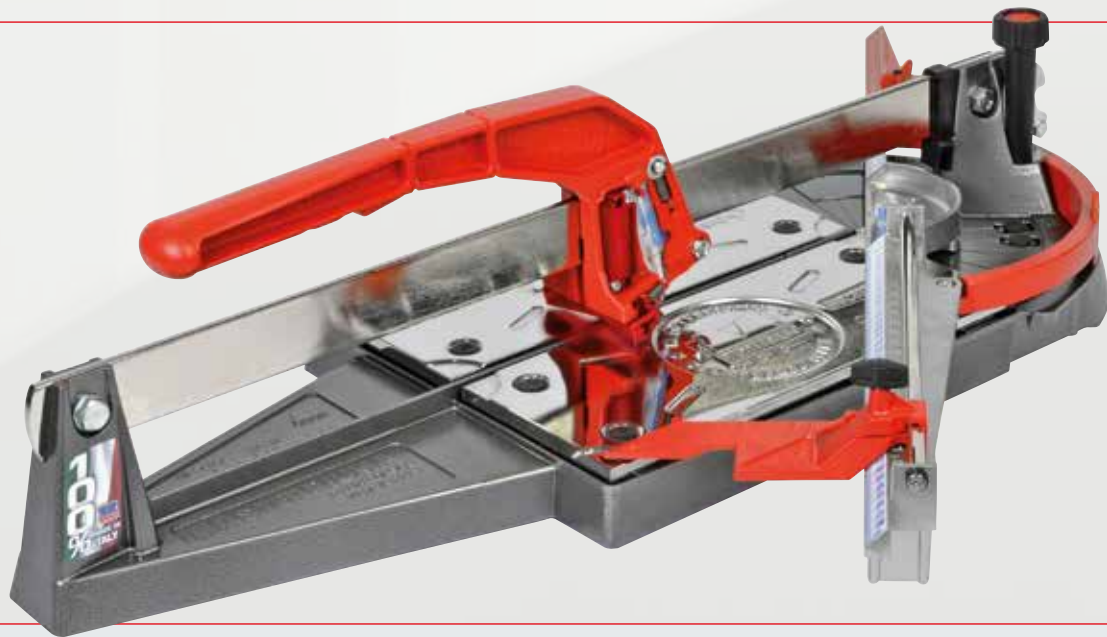

Art. 52P3

F.A.Q.

- IT** Qual è il modo migliore per utilizzare la tagliapiastrelle Masterpiuma?
- GB** What is the best way to use the Masterpiuma tile cutter?
- ES** ¿Cuál es la mejor manera de utilizar el cortador de azulejos Masterpiuma?

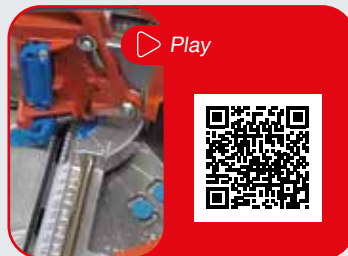

- IT** Come funziona la tagliapiastrelle Masterpiuma su piastrelle con superficie irregolare e strutturata?
- GB** How does the Masterpiuma tile cutter perform on tiles with uneven and textured surface?
- ES** ¿Cómo funciona la cortadora de baldosas con azulejos de superficie irregular?

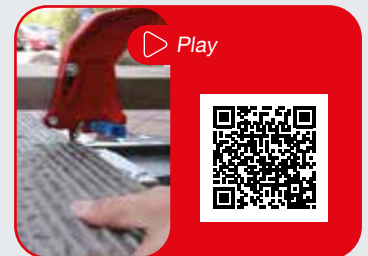

| Art. | | | | | | | kg | |
|-------|-----|------|-----------|-------------|--------|----------|------|-----|
| | cm | inch | cm | inch | max cm | max inch | | |
| 44P3 | 44 | 17 | 31 x 31 | 12 x 12 | 2 | 3/4 | 7,7 | C/1 |
| 52P3 | 52 | 20 | 37 x 37 | 14 x 14 | 2 | 3/4 | 8,2 | C/1 |
| 63P3 | 63 | 25 | 44 x 44 | 17 x 17 | 2 | 3/4 | 9,5 | C/1 |
| 75P3 | 75 | 29 | 53 x 53 | 21 x 21 | 2 | 3/4 | 11,8 | C/1 |
| 93P3 | 93 | 36 | 66 x 66 | 26 x 26 | 2 | 3/4 | 13,0 | C/1 |
| 125P3 | 125 | 49 | 88 x 88 | 34,5 x 34,5 | 2 | 3/4 | 24,0 | C/1 |
| 155P3 | 155 | 61 | 109 x 109 | 43 x 43 | 2 | 3/4 | 33,0 | C/1 |

Accessori | Optionals | Opcionales

MOSAKIT

pg.
10

Art. 58



- IT** Tappetino in gomma per mosaici, piastrelle in vetro, delicate e sottili (3mm).
- GB** Rubber pad for mosaic tiles, delicate and very thin 3mm glass tiles.
- ES** Alfombra de goma para mosaicos, baldosas de vidrio, delicadas y finas (3 mm).

BASEBOARD

pg.
10

Art. 64

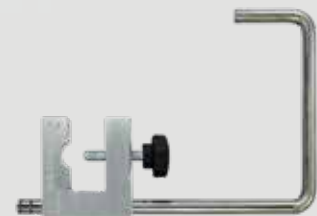





- IT** Riferimento aggiuntivo per grandi formati ideale per il taglio di listelli e di battiscopa.
- GB** Bracket precision for cutting strip tiles and skirting boards.
- ES** Referencia adicional para grandes formatos ideal para el corte de listones y zócalos.

PIUMA BASIC



Art. 63PB

| Art. |  | |  | |  | |  |  |
|-------|---|------|---|-------------|---|----------|---|---|
| | cm | inch | cm | inch | max cm | max inch | | |
| 63BP | 63 | 25 | 44 x 44 | 17 x 17 | 2 | 3/4 | 8,0 | C/1 |
| 75BP | 75 | 29 | 53 x 53 | 21 x 21 | 2 | 3/4 | 9,0 | C/1 |
| 93BP | 93 | 36 | 66 x 66 | 26 x 26 | 2 | 3/4 | 10,0 | C/1 |
| 125BP | 125 | 49 | 88 x 88 | 34,5 x 34,5 | 2 | 3/4 | 20,0 | C/1 |
| 155BP | 155 | 61 | 109 x 109 | 43 x 43 | 2 | 3/4 | 27,5 | C/1 |

CARAPAX



Art. CARAPAX



- IT** Protezione elastica per tagliapiastrelle.
- GB** Elastic protection for tile cutters.
- ES** Protección elástica para cortadoras de baldosas.

PIEDONE

Art. 449P



- IT** Sistema di spacco supplementare.
- GB** Additional splitting system.
- ES** Sistema de fractura suplementaria.

MINIMONTOLIT 2

Minimontolit Evolution 2 è una tagliapiastrelle di piccole dimensioni, progettata appositamente per gli utenti fai da te e per lavori meno complicati con piastrelle standard. Questa gamma di macchine consente di tagliare piastrelle di diverso spessore (0-20 mm) e con angoli variabili (0-60°) senza alcuna regolazione.





Minimontolit Evolution 2 is a small dimension tile cutter especially designed for DIY users and less complicated jobs with standard tiles. This range of machines enables you to cut tiles of different thickness (0-20mm) and at varying angles (0-60°) without any adjustment.

Minimontolit Evolution 2 es una cortadora de baldosas de pequeñas dimensiones para usuarios de bricolaje y trabajos menos complicados con baldosas estándar. Esta gama de máquinas le permite cortar baldosas de diferentes espesores (0-20 mm) y en ángulos variables (0-60°) sin ningún ajuste.



Art. 26A2



| Art. |  | |  | |  | |  |  |
|------|---|------|---|---------|---|----------|---|---|
| | cm | inch | cm | inch | max cm | max inch | | |
| 24 | 22 | 8 | 15 x 15 | 6 x 6 | 1,5 | 1/2 | 0,6 | C/6 |
| 26A2 | 36 | 14 | 25 x 25 | 10 x 10 | 2 | 3/4 | 2,8 | C/6 |
| 43A2 | 45 | 18 | 31 x 31 | 12 x 12 | 2 | 3/4 | 3,5 | C/2 |

MINIPIUMA

Questa mini tagliapiastrelle è consigliata sia ai piastrellisti professionisti che agli amanti del fai da te. È particolarmente adatta per l'installazione di piastrelle in grès porcellanato e mosaici in spazi ristretti, dove vengono comunemente installate piastrelle di piccole dimensioni, come cucine e bagni.





This mini tile cutter is suggested for both professional tilers and DIY lovers. It is particularly suitable for the installation of porcelain tiles and mosaic in confined spaces, where small tiles are commonly installed, such as kitchens and bathrooms.































Este mini cortador de azulejos se recomienda tanto para los colocadores profesionales como para los amantes del bricolaje. Es particularmente adecuado para la instalación de baldosas de porcelánico y mosaicos en espacios reducidos, donde se suelen instalar baldosas pequeñas, como cocinas y baños.



Art. 43PB



| Art. |  | |  | |  | |  |  |
|--------|---|------|---|---------|---|----------|---|---|
| | cm | inch | cm | inch | max cm | max inch | | |
| 26PBox | 36 | 14 | 25 x 25 | 10 x 10 | 2 | 3/4 | 5,8 | C/2 |
| 43PBox | 45 | 18 | 31 x 31 | 12 x 12 | 2 | 3/4 | 6,3 | C/2 |

| | | | |  <p>pg. 14</p> | | | | | | |  <p>pg. 15</p> | | | |  <p>pg. 13</p> | | | | |
|---|----------|---|--|---|----|-----|------|----|-----|------|---|------|-----|------|---|------|------|-------|-------|
| | | | | MINIMONTOLIT | | | | | | | MINIPIUMA | | | | PIUMA BASIC | | | | |
| | Art. |  | | 24 | 26 | 26A | 26A2 | 43 | 43A | 43A2 | 26P | 26PB | 43P | 43PB | 63PB | 75PB | 93PB | 125PB | 155PB |
|  | 245 | S/12 | | ✓ | ✓ | ✓ | ✓ | ✓ | ✓ | ✓ | ✓ | ✓ | ✓ | ✓ | ✓ | ✓ | ✓ | ✓ | ✓ |
|  | 245T | S/12 | | ✓ | ✓ | ✓ | ✓ | ✓ | ✓ | ✓ | ✓ | ✓ | ✓ | ✓ | ✓ | ✓ | ✓ | ✓ | ✓ |
|  | 445BP | S/1 | | | | | | | | | | | | | ✓ | ✓ | ✓ | | |
|  | 445BP12 | S/1 | | | | | | | | | | | | | | | | ✓ | ✓ |
|  | 264P | S/1 | | | | | | | | | ✓ | ✓ | ✓ | ✓ | | | | | |
|  | 264 | S/1 | | | ✓ | ✓ | | ✓ | ✓ | | | | | | | | | | |
|  | 264B | S/1 | | | | | ✓ | | | ✓ | | | | | | | | | |
|  | 259 | B/1 | | ✓ | | | | | | | | | | | | | | | |
|  | 446P | B/1 | | | | | | | | | | | | | ✓ | ✓ | ✓ | ✓ | ✓ |
|  | 318 | B/1 | | | ✓ | ✓ | ✓ | ✓ | ✓ | ✓ | | | | | ✓ | ✓ | ✓ | ✓ | ✓ |
|  | 448P | B/1 | | | | | | | | | ✓ | ✓ | ✓ | ✓ | | | | | |
|  | 429P-EVO | S/1 | | | | | | | | | ✓ | ✓ | ✓ | ✓ | | | | | |
|  | 428T | S/1 | | | | | | | | | | | | | ✓ | ✓ | ✓ | ✓ | ✓ |
|  | 460P | B/1 | | | | | | | | | | | | | ✓ | ✓ | ✓ | ✓ | ✓ |
|  | 458P | B/1 | | | | | | | | | ✓ | ✓ | ✓ | ✓ | | | | | |
|  | 452P | S/1 | | | | | | | | | ✓ | ✓ | ✓ | ✓ | | | | | |
|  | 454P | S/1 | | | | | | | | | | | | | ✓ | ✓ | ✓ | | |
|  | 456P | S/1 | | | | | | | | | | | | | | | | ✓ | ✓ |
|  | 418P | S/1 | | | | | | | | | | | | | ✓ | ✓ | ✓ | ✓ | ✓ |
|  | 415P | S/1 | | | | | | | | | | | | | | | | ✓ | ✓ |
|  | 280 | S/1 | | | | ✓ | ✓ | | ✓ | ✓ | | | | | | | | | |
|  | 280P | S/1 | | | | | | | | | ✓ | ✓ | ✓ | ✓ | | | | | |
|  | 277 | B/1 | | ✓ | ✓ | ✓ | ✓ | ✓ | ✓ | ✓ | | | | | | | | | |
|  | 277P | B/1 | | | | | | | | | ✓ | ✓ | ✓ | ✓ | | | | | |
|  | 281 | S/1 | | | | | | | | | | | | | ✓ | ✓ | ✓ | | |
|  | 281H | S/1 | | | | | | | | | | | | | | | | ✓ | ✓ |
|  | 440P2 | S/1 | | | | | | | | | | | | | ✓ | ✓ | ✓ | ✓ | ✓ |

| | | | |  | | | | | | | |  | | | | | | | |
|---|-------|---|--|---|------|------|------|------|-------|-------|------|---|------|------|------|-------|-------|--|--|
| | | | | MASTERPIUMA P2 | | | | | | | | MASTERPIUMA P3 | | | | | | | |
| | Art. |  | | 44P2 | 52P2 | 63P2 | 75P2 | 93P2 | 125P2 | 155P2 | 44P3 | 52P3 | 63P3 | 75P3 | 93P3 | 125P3 | 155P3 | | |
|  | 245 | S/12 | | ✓ | ✓ | ✓ | ✓ | ✓ | ✓ | ✓ | ✓ | ✓ | ✓ | ✓ | ✓ | ✓ | ✓ | | |
|  TITANIUM | 245T | S/12 | | ✓ | ✓ | ✓ | ✓ | ✓ | ✓ | ✓ | ✓ | ✓ | ✓ | ✓ | ✓ | ✓ | ✓ | | |
|  | 505 | S/1 | | ✓ | ✓ | ✓ | | | | | ✓ | ✓ | ✓ | | | | | | |
| | 506 | S/1 | | | | | ✓ | ✓ | ✓ | ✓ | | | | ✓ | ✓ | ✓ | ✓ | | |
|  | 507 | B/1 | | | | | | | | | ✓ | ✓ | ✓ | ✓ | ✓ | ✓ | ✓ | | |
|  | 446P | B/1 | | ✓ | ✓ | ✓ | ✓ | ✓ | ✓ | ✓ | | | | | | | | | |
|  | 318 | B/1 | | ✓ | ✓ | ✓ | ✓ | ✓ | ✓ | ✓ | | | | | | | | | |
|  | 515-5 | B/1 | | ✓ | ✓ | ✓ | ✓ | ✓ | ✓ | ✓ | ✓ | ✓ | ✓ | ✓ | ✓ | ✓ | ✓ | | |
|  | 428P2 | S/1 | | ✓ | ✓ | ✓ | ✓ | ✓ | ✓ | ✓ | ✓ | ✓ | ✓ | ✓ | ✓ | ✓ | ✓ | | |
|  | 455P2 | S/1 | | ✓ | ✓ | | | | | | ✓ | ✓ | | | | | | | |
| | 456P2 | S/1 | | | | ✓ | ✓ | ✓ | | | | | ✓ | ✓ | ✓ | | | | |
| | 457P2 | S/1 | | | | | | | ✓ | ✓ | | | | | | ✓ | ✓ | | |
|  | 459P | S/1 | | ✓ | ✓ | ✓ | ✓ | ✓ | ✓ | ✓ | ✓ | ✓ | ✓ | ✓ | ✓ | ✓ | ✓ | | |
|  | 418P | S/1 | | ✓ | ✓ | ✓ | ✓ | ✓ | ✓ | ✓ | ✓ | ✓ | ✓ | ✓ | ✓ | ✓ | ✓ | | |
| | 415P | S/1 | | | | | | | ✓ | ✓ | | | | | | ✓ | ✓ | | |
|  | 480P2 | B/1 | | ✓ | ✓ | | | | | | ✓ | ✓ | | | | | | | |
| | 481P2 | B/1 | | | | ✓ | ✓ | ✓ | ✓ | ✓ | | | ✓ | ✓ | ✓ | ✓ | ✓ | | |
|  | 281 | S/1 | | ✓ | ✓ | ✓ | ✓ | ✓ | | | ✓ | ✓ | ✓ | ✓ | ✓ | | | | |
| | 281H | S/1 | | | | | | | ✓ | ✓ | | | | | | ✓ | ✓ | | |
|  | 440P2 | S/1 | | ✓ | ✓ | ✓ | ✓ | ✓ | ✓ | ✓ | ✓ | ✓ | ✓ | ✓ | ✓ | ✓ | ✓ | | |

300 PROJECT 300

Tecnologie per la lavorazione delle lastre ceramiche
Technologies for processing ceramic slabs
Tecnologías para el procesamiento de losas cerámica

IT

Sistema per la movimentazione e la lavorazione di piastrelle giganti by Montolit

Le caratteristiche principali da tenere in considerazione nella posa di queste piastrelle sono: dimensione, flessibilità, fragilità e peso.

Il PROGETTO 300 by Montolit comprende una linea di attrezzature espressamente progettata per permettere di affrontare la posa delle lastre con facilità e risultati eccellenti.

ES

Sistema para el desplazamiento y la elaboración de baldosas de grandes dimensiones por Montolit.

Las características principales para considerar en la colocación de estas baldosas son: dimensión, flexibilidad, fragilidad y peso. El PROYECTO 300 por Montolit comprende una línea de equipamiento diseñado exclusivamente para permitir la colocación de las losas con facilidad y resultados excelentes.

GB

System for handling and machining large format tiles by Montolit.

The main features to keep in mind when laying these tiles are: size, flexibility, fragility and weight.

PROJECT 300 by Montolit includes a line of equipment expressly designed to allow for easy installation of slabs with excellent results.

Un sistema completo
A complete system
Un sistema completo



GECO ROBOT

NEW

CE





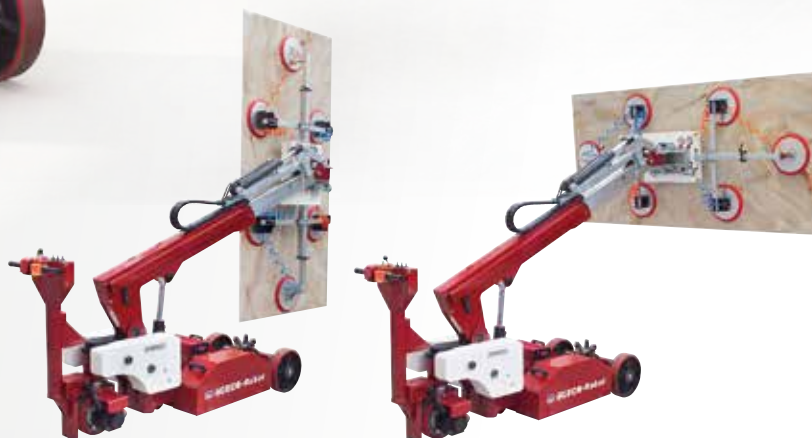
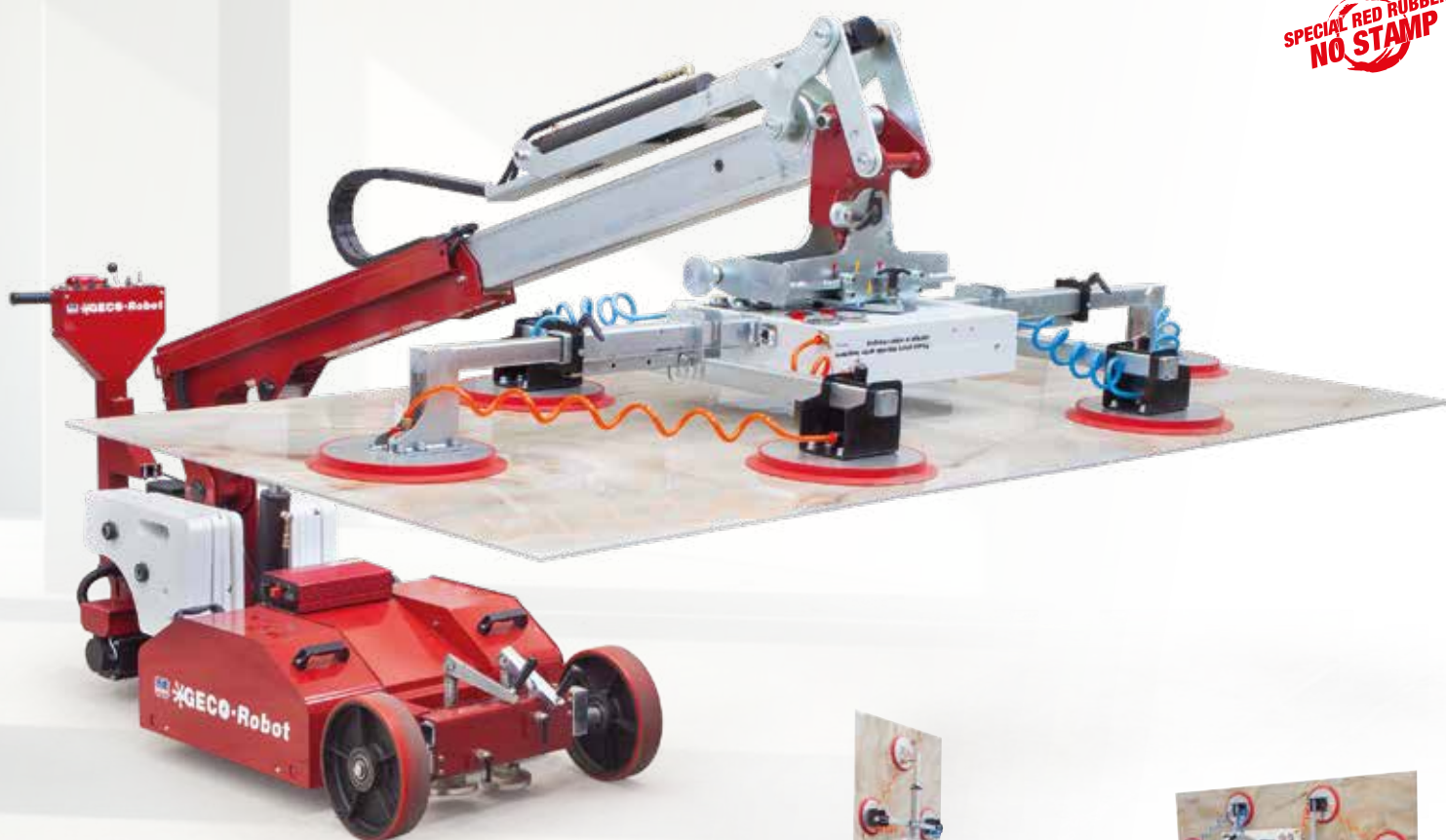

**SPECIAL RED RUBBER
NO STAMP**

IT Sistema robotizzato a batteria per il sollevamento e la movimentazione delle lastre.

GB Battery powered robotic system for lifting and handling slabs.

ES Sistema robótico a baterías para elevación y manipulación de losas.



| | | | | | | |
|---|---|---|---|---|---|---|
|  |  |  |  |  |  |  |
| mt. | kg | mm | kg | kg | | |
| 3,25 | 190 / 485 | 6 x Ø 300 | 770 | 20 x 14 pz | 2 x 12V-80A | 220x80x120(h) 43kg |



GOAL

- IT Carrello polifunzionale per il trasporto e la lavorazione di lastre.
- GB Multi-purpose bogie for transporting and machining slabs.
- ES Carro multifuncional para el transporte y la elaboración de losas



Pos. 1
Movimentazione
Handling
Desplazamiento



Pos. 2
Stesura adesivo
Affixing the adhesive
Esparcimiento del adhesivo







| Art. |  cm |  kg |  kg |  |
|------------|--|--|--|---|
| 300-85-EVO | 150 x 70 x 150 (h) | 28 | 260 | C/1 |

LIFTERS

- IT Sollevatori livellanti.
- GB Leveling lifters.
- ES Sistema de elevación y nivelación





| Art. |  h |  kg |  kg |  | |
|---------|---|--|--|---|-----|
| LIFTERS | Set 2 pcs. | 30 | 2,95 | 25 | S/1 |



CORNER

- IT Paraspigoli.
- GB Corner protectors.
- ES Protectores de esquinas.

| Art. |  | | Pz./pcs. |  |
|-----------|---|------------|----------|---|
| | mm | inch | | |
| 300-95-04 | 3 ÷ 4 | 1/8 ÷ 5/32 | Set 4 | B/1 |
| 300-95-06 | 5 ÷ 6 | 3/16 ÷ 1/4 | Set 4 | B/1 |
| 300-95-10 | 8 ÷ 10 | 5/16 ÷ 3/8 | Set 4 | B/1 |
| 300-95-12 | 11 ÷ 12 | 7/16 ÷ 1/2 | Set 4 | B/1 |



GECO e-power

NEW

CE

- IT Ventosa professionale a batteria.
- GB Professional battery-powered suction cup.
- ES Ventosa profesional a batería.

Batteria ricaricabile
Rechargeable battery
Batería recargable



SPECIAL RED RUBBER
NO STAMP

NON STOP OPERATION
16 HOURS

ELECTRONIC
CONTROL DISPLAY



| Art. | | | | | | |
|--------------|---------------------------|--------------|-------|-----|------|-----|
| | h | mm | kg | | | |
| GECO E-POWER | 3,7VDC -Li-ion 5 Ah- 18Wh | USB · Type-C | 6 ÷ 8 | 200 | 0,93 | S/1 |

VT-300

- IT Doppia ventosa per avvicinare e allineare le lastre.
- GB Double suction cup to move close and align slabs.
- ES Doble ventosa para acercar y alinear las losas.



SPECIAL RED RUBBER
NO STAMP

| Art. | | |
|--------|-----|-----|
| | mm | |
| VT-300 | 150 | C/1 |

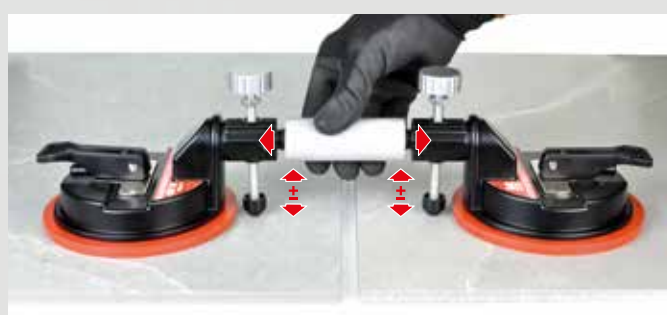
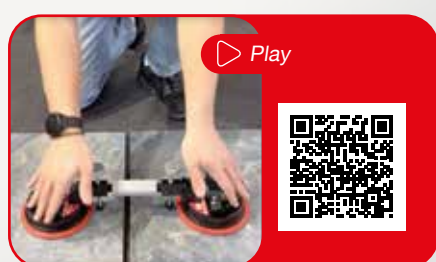

GECONE e-power



IT Ventosa super professionale a batteria.
 GB Super professional battery-powered suction cup.
 ES Ventosa super profesional a batería.



SPECIAL RED RUBBER
NO STAMP



2 batterie ricaricabili ed intercambiabili
 2 batteries rechargeable and interchangeable
 2 baterías recargable e intercambiable

| Art. | | | | | | |
|--------|----|-----------------------------|---|-----------|-----|-----|
| | N° | | h | mm | kg | BOX |
| GECONE | 2 | 12VDC -Li-ion 1,5 Ah - 18Wh | 2 | 300 x 160 | 1,6 | S/1 |

Display di controllo livello del vuoto
 Vacuum level control display
 Pantalla de control del nivel del vacío

Display di controllo batteria
 Battery control display
 Pantalla de control de la batería



pg. 52 → Ricambi
 Spare parts
 Recambios

LIFT e-power



- IT Barra singola con due ventose.
- GB Single bar with two suction cups.
- ES Barra única con dos ventosas.

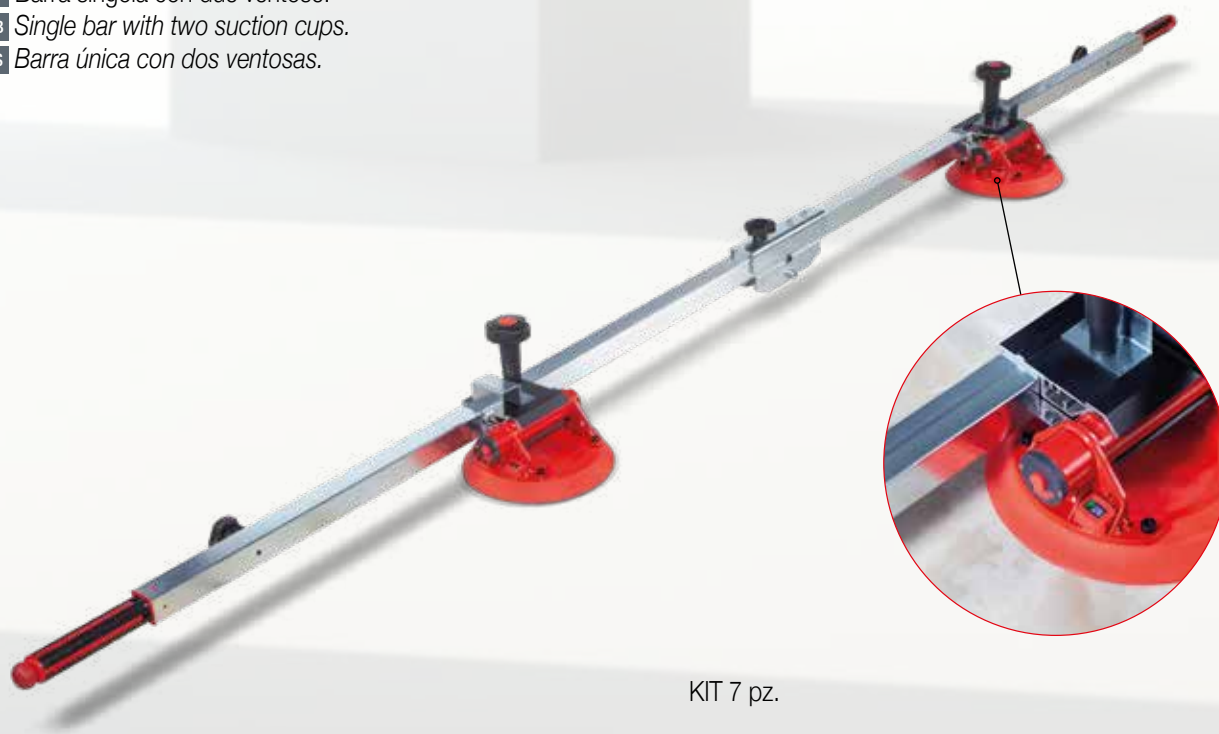

KIT 7 pz.

| Art. | kg | BOX |
|--------------|----|-----|
| LIFT e-power | 10 | C/1 |



OPTIONALS Superlift e-power

Art. SUPERLIFT e-power-01

- IT Ventosa Extra - 2 pz.
- GB Extra suction cup - 2 pcs.
- ES Ventosa extra - 2 Pz.

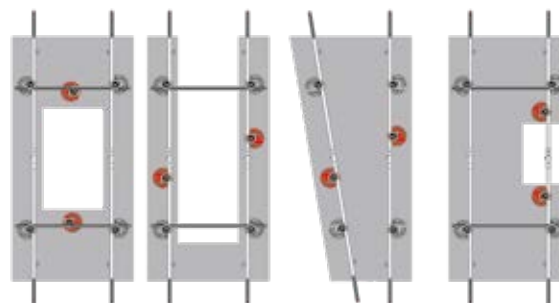
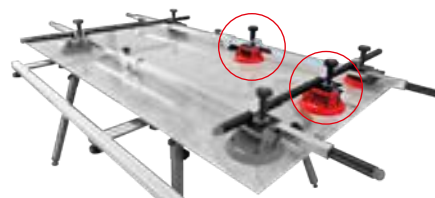

Art. SUPERLIFT e-power-02

- IT Sistema di sicurezza per lastre corrugate - 4 pz.
- GB Extra safety hooks for slabs - 4 pcs.
- ES Sistema de seguridad para placas corrugadas - 4 pz.



SUPERLIFT e-power



IT Sistema modulare per la movimentazione di grandi lastre.
 GB Modular handling system for slabs.
 ES Sistema modular de movilización de grande losas.

SPECIAL RED RUBBER
NO STAMP

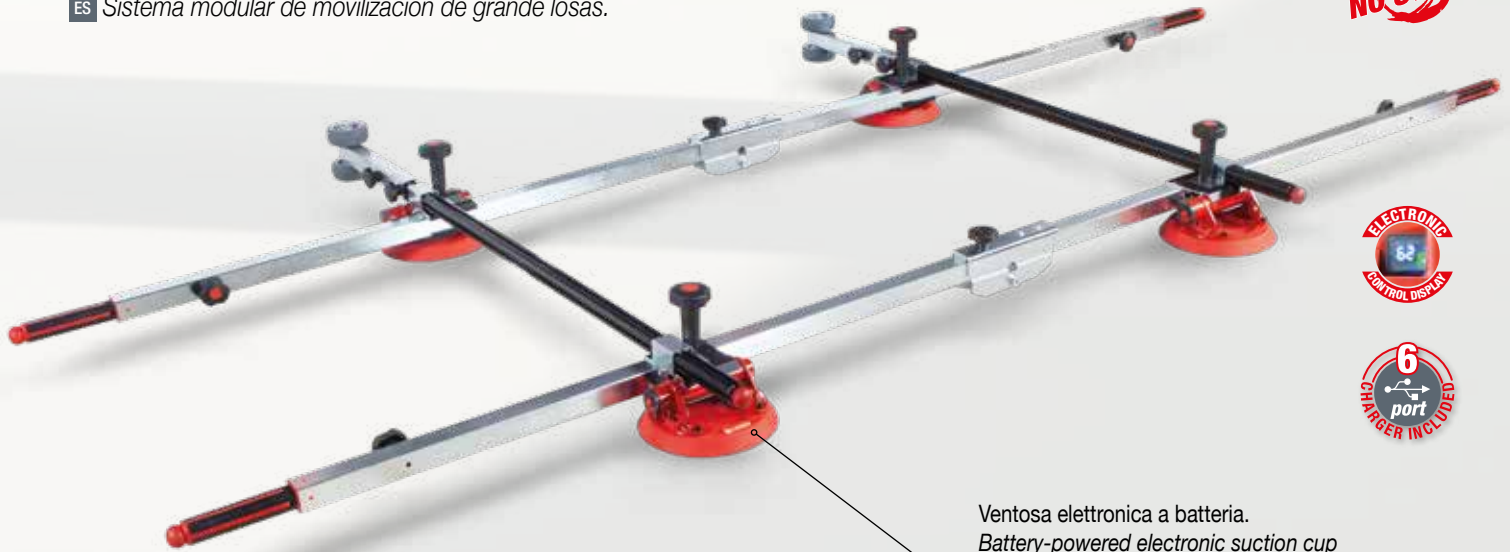

Ventosa elettronica a batteria.
 Battery-powered electronic suction cup
 Ventosa electrónica a batería

KIT 20 pz.



| Art. | kg | BOX |
|-------------------|----|-----|
| SUPERLIFT e-power | 26 | C/1 |

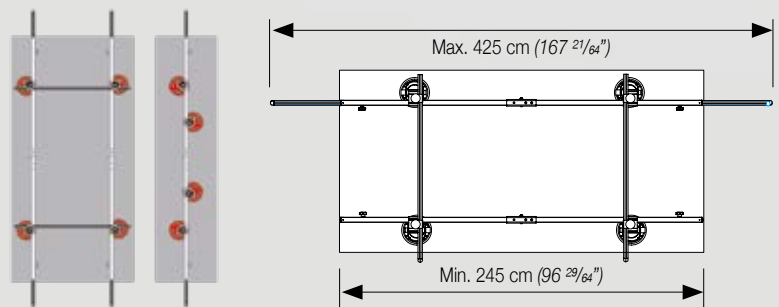

▶ Play

OPTIONAL

Art. 300-20-PLUS

- IT Kit prolunga per TABLE-ONE.
- GB Extension kit for TABLE-ONE.
- ES Kit de extensión para TABLE-ONE.

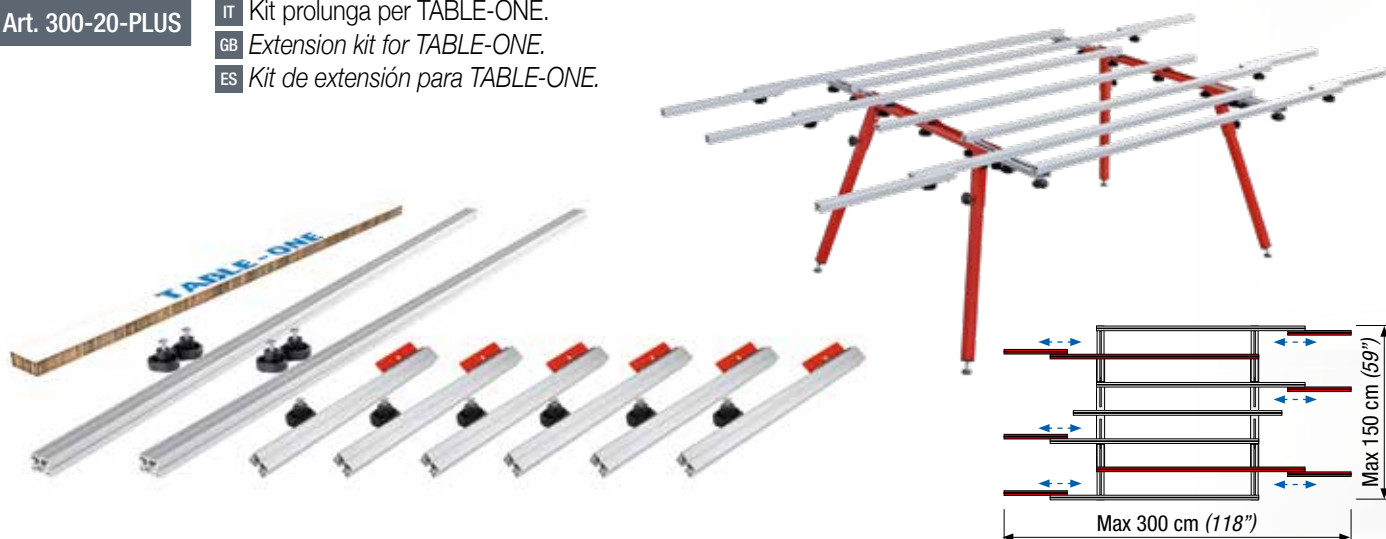

OPTIONAL

Art. 300-25

- IT Barra di alluminio extra.
- GB Extra aluminium bar.
- ES Barra extra de aluminio.



Due banchi combinati | Two combined benches | Dos bancos combinados



TABLE-ONE



- IT Banco da lavoro.
- GB Work-table.
- ES Banco de trabajo.

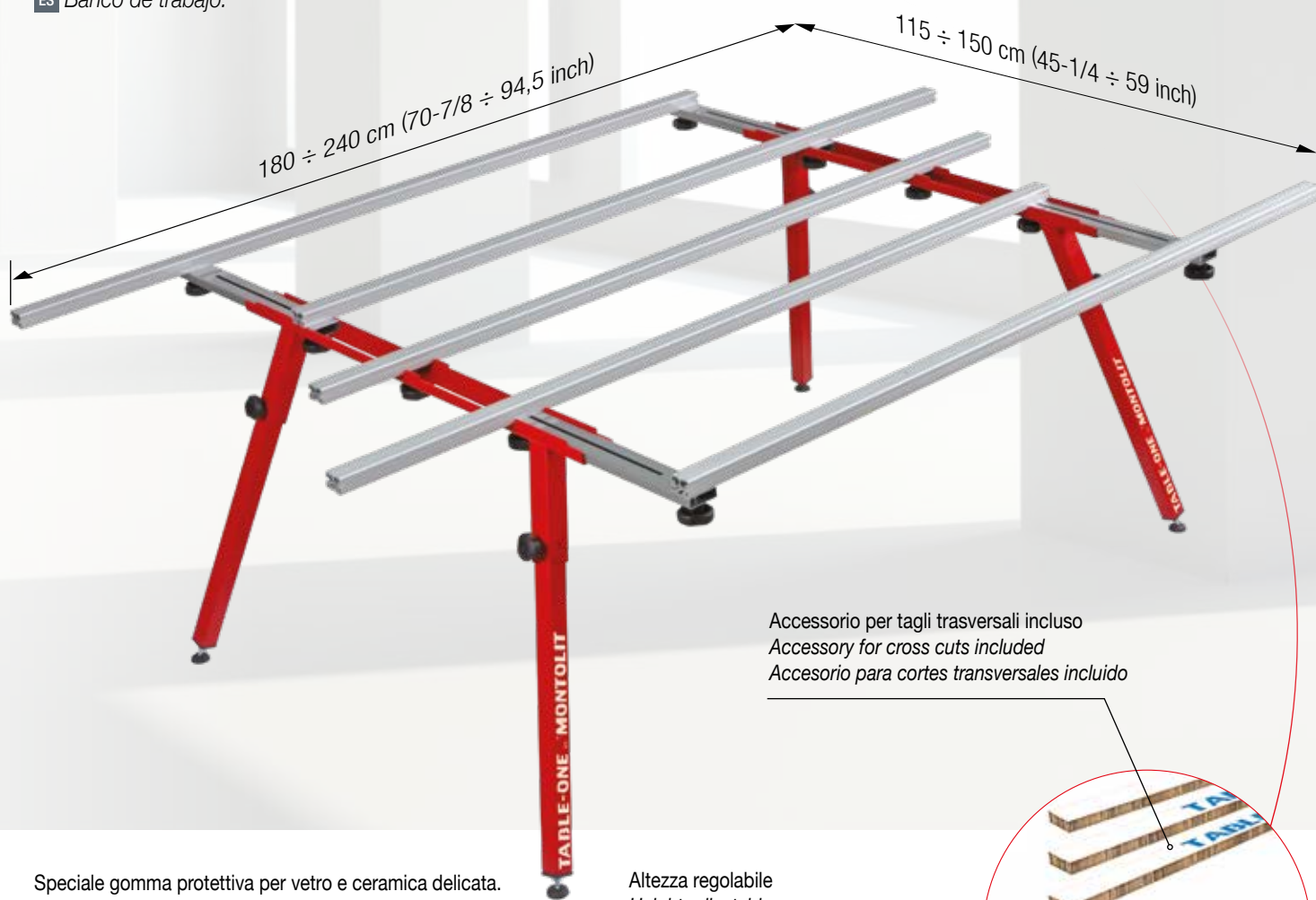

Accessorio per tagli trasversali incluso
 Accessory for cross cuts included
 Accesorio para cortes transversales incluido

Speciale gomma protettiva per vetro e ceramica delicata.
 Special anti-slip rubber for glass and soft ceramics
 Goma antideslizante especial para vidrio y cerámica blanda

Altezza regolabile
 Height adjustable
 Altura ajustable

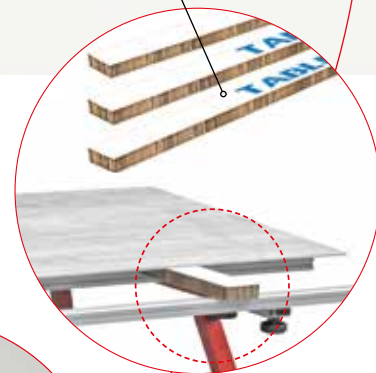
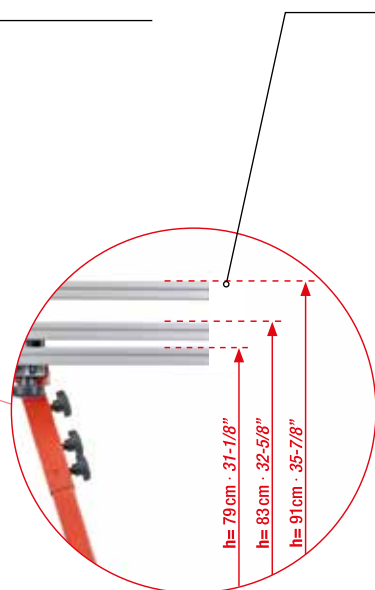
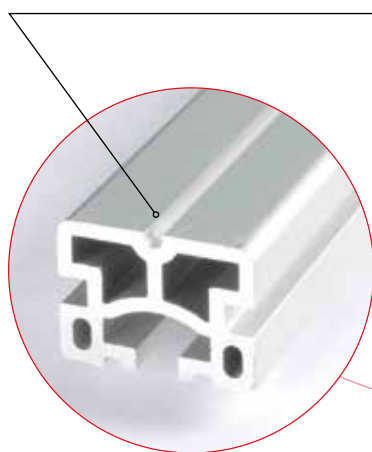

Lunghezza e larghezza regolabili
 Adjustable in length and width
 Ajustable en largo y ancho

| Art. | MIN | | MAX | | kg | BOX |
|--------|-----------|-----------------|-----------|-------------|----|-----|
| | cm | inch | cm | inch | | |
| 300-20 | 115 x 180 | 45-1/4 x 70-7/8 | 150 x 240 | 59 x 94-1/2 | 34 | C/1 |

FL3 FLASH LINE



La rivoluzione del taglio sul grande formato
The cutting revolution for large format tiles
 La revolución del corte para grandes formatos

Progettata in collaborazione con il Politecnico dell'Università di Milano, permette il taglio manuale di lastre in grès porcellanato di grandi dimensioni fino ad 1 cm di spessore.

Designed in cooperation with the "Politecnico of Milan University", FL3 allow the manual cut of gres porcelain slabs up to 1cm thickness.

Diseñada en colaboración con el Politécnico de la Universidad de Milán, Flash Line FL3, permite el corte manual de placas de gres porcelánico de grandes dimensiones de hasta 1 cm de espesor.

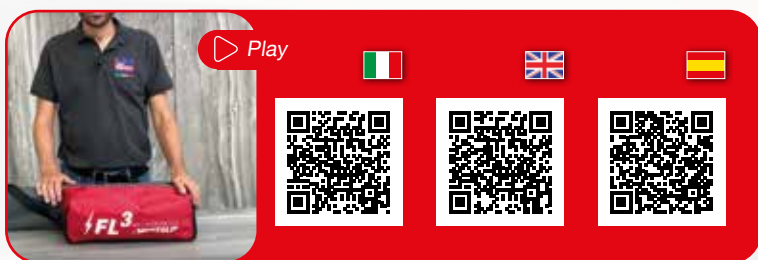

Senza ventose
 Without suction cup
 Sin ventosas



Facile e immediato sistema di selezione delle rotelle in Titanio.
 Titanium wheels selection system. Easy and immediate.
 Sistema de selección de las ruedas de Titanio. Sencillo y rápido.

| | | | | | |
|------|-----------|-------------|----------------------------------|-----------|-----|
| Art. | | | | | |
| FL3 | cm 340 | inch 134 | max cm 1 max inch 3/8 | kg 8,0 | C/1 |

Sistema di selezione delle rotelle in Titanio

- 1 Titanium wheels selection system
Sistema de selección de las ruedas de Titanio

Aggancio elastico rapido

- 2 Quick elastic connection
Enganche elástico rápido

Separatore con doppio sistema di spacco

- 3 Double splitting system
Separador con doble sistema de rotura

Ø 20mm (3/4")

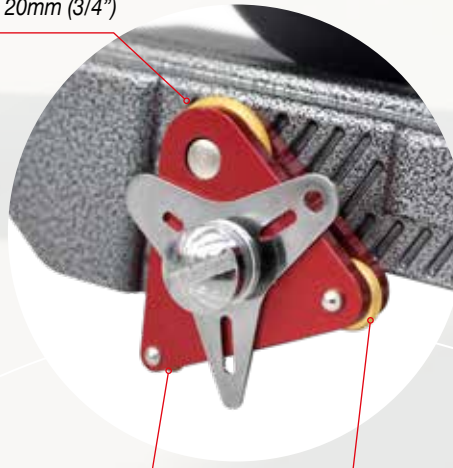

Ø 12mm (1/2")

Ø 8mm (5/16")



1



2



3 x 120 cm



3

pg. 47



pg. 108 → Espositore
Display
Expositor

pg. 52 → Ricambi
Spare parts
Recambios

MOTO FLASH LINE 2



CE

Un sistema senza limiti per il taglio a secco

A NO-LIMITS innovative machine

Un sistema para el corte en seco SIN LÍMITES

Evoluzione motorizzata del sistema di taglio manuale Flash line per piastrelle e lastre fino a 4 cm di spessore. La macchina ha in sè tutti i vantaggi di FLASH LINE (facilità di trasporto, leggerezza, precisione, sistema antiscivolo brevettato senza utilizzo di ventose) con l'aggiunta di una testa motorizzata munita di disco diamantato professionale per ceramica e gres porcellanato.

Motorized evolution of manual dry cutting system FLASH LINE. The machine can cut tiles and slabs up to 4 cm (1,5") thickness. The innovative MOTO FLASH LINE includes all the advantages of the Flash Line machine with the addition of a motor power unit complete with a diamond blade dedicated to porcelain and ceramic.

Evolución motorizada del sistema de corte manual Flash line para azulejos y placas de hasta 4 cm de espesor. La máquina dispone de todas las ventajas de FLASH LINE con el añadido de una cabeza motorizada equipada con disco diamantado profesional para cerámica y gres porcelánico.



| Art. |  |  | |  | |  | |  |  |
|---------------------------------|---|---|------|---|----------|---|------------|---|---|
| | | cm | inch | max cm | max inch | mm | inch | | |
| MFL2-SH | 230V~ 1,6kW (2,1HP) 50/60 Hz · 5500 rpm | 330 | 130 | 2 | 3/4 | 150/30 | 6 / 1-3/16 | 12,3 | C/1 |
| MFL2-SH-115V | 110/120V~ 1,6kW (2,1HP) 50/60 Hz · 5000 rpm | 330 | 130 | 2 | 3/4 | 150/30 | 6 / 1-3/16 | 12,8 | C/1 |
| MFL2-SH-PU (Power Unit) | 230V~ 1,6kW (2,1HP) 50/60 Hz · 5500 rpm | 330 | 130 | 2 | 3/4 | 150/30 | 6 / 1-3/16 | 6,5 | C/1 |
| MFL2-SH-PU-115V (Power Unit) | 110/120V~ 1,6kW (2,1HP) 50/60 Hz · 5000 rpm | 330 | 130 | 2 | 3/4 | 150/30 | 6 / 1-3/16 | 6,9 | C/1 |

Collegare ad un aspiratore professionale

- 1 Connect to a professional vacuum cleaner
- Conectar a un aspirador profesional

Art. TCS150MFL

Disco di serie

- 2 Standard blade
- Disco de serie



Art. MFL2-SH



Art. MFL2-SH-PU





Massima ergonomia
 Best-in-class ergonomics
 Máxima ergonomía



4 cm 1,5"



Art. LPH190MFL

Aspirazione "NO DUST" con regolazione automatica, garantisce l'assenza di polvere ed un raffreddamento ottimale
Self-adjusted vacuum system "no DUST", allows the full dust removal and a perfect cooling.
 Aspiración «NO DUST» con regulación automática, garantiza la ausencia de polvo y una refrigeración óptima.

OPTIONAL

Art. CSS150

Disco diamantato supersottile per lastre sottili in grès porcellanato.
Super thin diamond blade for porcelain stoneware slim slabs.
 Disco diamantado súper delgado para losas finas de grés porcelánico.

| | | | |
|---|-------------------------------|---|----------------------------|
|  | Ø 150/30mm Ø 6/1-3/16 inch |  | 3 ÷ 8mm 1/8 ÷ 5/16 inch |
|---|-------------------------------|---|----------------------------|

Massima finitura - velocità ridotta - non forzare
 Clean cut - low speed - don't force while cutting
 Corte limpio - velocidad reducida - No forzar



pg.
70 →

OPTIONAL

Art. TBH150

Disco diamantato per grès porcellanato alto spessore e granito.
Diamond blade for porcelain stoneware high thickness and granite.
 Disco diamantado para grés porcelánico de gran espesor y granito.

| | | | |
|---|-------------------------------|---|-----------------------------|
|  | Ø 150/30mm Ø 6/1-3/16 inch |  | 12 ÷ 20mm 1/2 ÷ 3/4 inch |
|---|-------------------------------|---|-----------------------------|

Speciale per Grès porcellanato da 2 cm max
 Special Gres Porcellanato max 2cm
 Especial 2 cm Gres Porcelánico



pg.
74 →

OPTIONAL

Art. LPH190MFL

Disco diamantato per grès porcellanato alto spessore e granito.
Diamond blade for porcelain stoneware high thickness and granite.
 Disco diamantado para grés porcelánico de gran espesor y granito.

| | | | |
|---|---------------------------------|---|-------------------------------|
|  | Ø 190/30mm Ø 7,5/1-3/16 inch |  | 20 ÷ 40mm 3/4 ÷ 1-1/2 inch |
|---|---------------------------------|---|-------------------------------|

Speciale per Grès porcellanato da 4 cm max
 Special High Thickness Gres Porcellanato max 4cm
 Especial 4 cm Gres Porcelánico



OPTIONAL

Art. MT-H00V

Aspiratore professionale per polveri e liquidi.
Professional vacuum cleaner for dust and liquids.
 Aspirador profesional para polvos y líquidos.

| | CAPACITA' BIDONE TANK CAPACITY CAPACIDAD DEL TANQUE | FLUSSO ARIA MAX AIR FLOW MAX FLUJO DE AIRE MAX | |
|-------------|---|--|----|
| | L | m ³ /h | kg |
| 230V~/1,2kW | 50 | 166 (45 lt/sec) | 11 |

Ricambi | Spare parts | Ricambios

Art. MT-H00V01



Elemento filtrante
 Filter cartridge
 Elemento filtrante

Art. MT-H00V02



Sacchetto raccogli-polvere
 Dust collecting bag
 Bolso para recoger el polvo



BATTLE



**SPECIAL RED RUBBER
NO STAMP**

- IT Ventosa battente per piastrelle e lastre.
- GB Thumping suction cup for tiles and slabs.
- ES Ventosa vibradora para baldosas y losas.



pg. 52 → Ricambi
→ Spare parts
→ Repuestos

pg. 107 → Espositore
→ Display
→ Expositor

| Art. | | | MIN./MAX | | | |
|--------|------------------------------|---|----------------|-------------|------|-----|
| | | h | rpm | mm (inch) | kg | BOX |
| BATTLE | 8,4V -Li-ion 2,5 Ah- 21Wh | 2 | 5.000 ÷ 18.000 | 120 (4-3/4) | 0,95 | S/1 |

BATTLE PRO

- IT Ventosa battente per piastrelle e lastre.
- GB Thumping suction cup for tiles and slabs.
- ES Ventosa vibradora para baldosas y losas.



3 Velocità
3 Speed
3 velocidades



**SPECIAL RED RUBBER
NO STAMP**



2 batterie 16V 2 Ah
2 battery 16V 2 Ah
2 baterías 16V 2Ah



Art. BTL-P-13 Estensore di vibrazione **INCLUSO**, area interessata più ampia
Art. BTL-P-13 **INCLUDED** Vibration expander, larger area affected
Art. BTL-P-13 **INCLUIDO** Expansor de vibración, mayor área afectada

pg. 52 → Ricambi
→ Spare parts
→ Recambios

| Art. | | | MIN./MAX | | | |
|---------------|----------------------------|-----|----------------|-------------|------|-----|
| | | h | rpm | mm (inch) | kg | BOX |
| BATTLE-PRO-2B | 16V -Li-ion 2 Ah - 32Wh | 2,5 | 5.000 ÷ 12.000 | 130 (5-1/8) | 1,35 | S/1 |

BATTILONE

- IT Ventosa battente per piastrelle e lastre.
- GB Thumping suction cup for tiles and slabs.
- ES Ventosa vibradora para baldosas y losas.



2 batterie 20V 1,5 Ah
 2 battery 20V 1,5 Ah
 2 baterías 20V 1,5 Ah

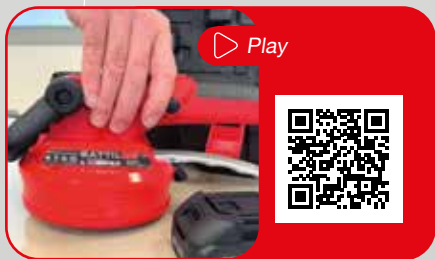

Art. BTL-P-13 Estensore di vibrazione **INCLUSO**, area interessata più ampia
 Art. BTL-P-13 **INCLUDED** Vibration expander, larger area affected
 Art. BTL-P-13 **INCLUIDO** Expansor de vibración, mayor área afectada

pg. 52 **Ricambi**
Spare parts
Recambios



| Art. | | | | MIN./MAX rpm | mm (inch) | | |
|-----------|---|------------------------------|---|-----------------|---------------|-----|-----|
| BATTILONE | 2 | 20V -Li-ion 1,5 Ah - 30Wh | 2 | 4.000 ÷ 7.000 | 160 (6-5/16) | 2,2 | S/1 |

TOPPROFILE



L'innovativo sistema di PROFILATURA
The innovative PROFILING SYSTEM
 El innovador SISTEMA DE CANTEADO

Sistema di profilatura a secco per piastrelle e lastre, consente di realizzare jolly, biselli, profili raggiati su lastre in gres porcellanato, ceramica e qualsiasi materiale lapideo di ogni dimensione.

Dry profiling system for tiles and slabs, allows for the processing of miter cuts, bevels, radiused profiles on porcelain, ceramic and any stone material of any size.

Sistema de perfilado en seco para baldosas y losas, permite elaborar cortes a inglete, biseles y perfiles redondeados en porcelana, cerámica y cualquier material pétreo de cualquier tamaño.



Art.



kg



TOPPROFILE

230 V~ · 800 W · 50/60 Hz · 11.000 RPM

4,7

C/1

TOPPROFILE-115V

110/120 V~ · 900 W · 50/60 Hz · 11.000 RPM

4,7

C/1



1 Protezione in policarbonato
Polycarbonate protection
Protección de policarbonato

2 Telaio in alluminio
Aluminium frame
Bastidor de aluminio

3 Base in nylon intercambiabile
Interchangeable nylon base
Base de nylon intercambiabile

4 Pratica e robusta borsa in cordura per il trasporto
Practical, sturdy Cordura fabric carrying bag
Bolsa con asas para el transporte

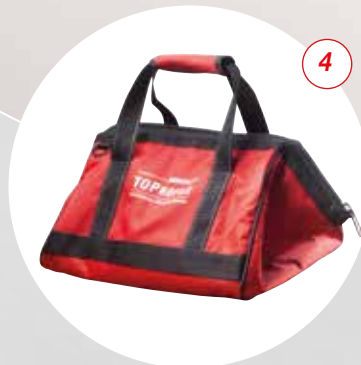
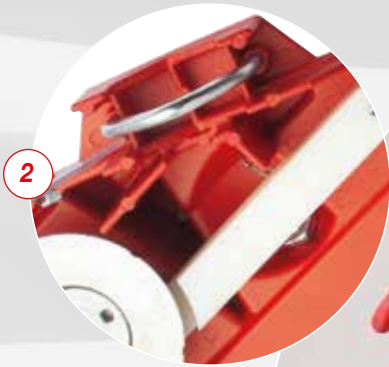

pg.
33

Aspiratore professionale per polveri e liquidi
Professional vacuum cleaner for dust and liquids
Aspirador profesional para polvos y líquidos

**INCLUSO
INCLUDED
INCLUIDO**

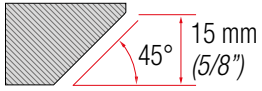

SUPERPROFILE



Art. FPE15SP



Grana media | *Medium grain* | *Grano medio*

TOPPROFILE



Art. FPE15TP



Grana media | *Medium grain* | *Grano medio*

OPTIONAL

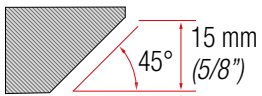

Art. FPE15SPGF



Grana fine | *Fine grain* | *Grano fino*

Art. FPE15TPGF



Grana fine | *Fine grain* | *Grano fino*

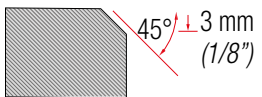

Art. FPE03SP



Art. FPE03TP

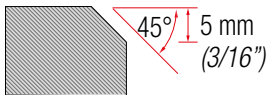

Art. FPE05SP



Art. FPE05TP

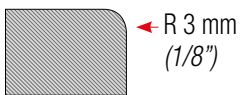

Art. FPB03SP



Art. FPB03TP

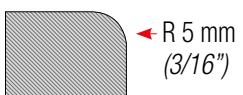

Art. FPB05SP



Art. FPB05TP

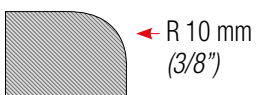

Art. FPB10SP



Art. FPB10TP

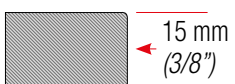

Art. FPZS15SP



Art. FPZS15TP



Attrezzature elettriche e manuali
Electric and manual equipment
Equipos electricos y manuales



F1 BROOKLYN



- IT** Taglierina elettrica ad acqua.
- GB** Electric, water-cooled diamond tile saws.
- ES** Cortadora eléctrica con agua.

Piani in acciaio inox
Stainless steel work surfaces
Planos de trabajo en acero inoxidable

Motore potente 3hp, disco Ø 250mm
Powerful 3hp engine, blade Ø 250mm
Potente con motor de 3hp, disco de Ø250mm

Art. SCX250
DNA - Disco diamantato incluso
DNA - Diamond blade included
DNA - Disco diamantado incluido

GOLD LINE
"HIGH TECHNOLOGY"



Struttura in alluminio ed acciaio rinforzato zincato e verniciato
Aluminum frame, reinforced with painted galvanized steel
Estructura de aluminio, reforzada con acero galvanizado pintado.

Squadra goniometrica
Goniometrical square
Escuadra goniométrica

Art. F1-181

Pratica leggera e compatta
Practical, lightweight and compact
Práctica, ligera y compacta



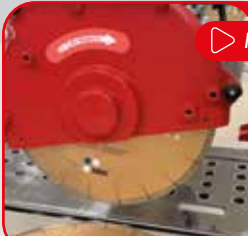

Sistema brevettato per una planarità ottimale (151/181cm)
Patented adjustable legs system (151/181cm)
Sistema de ajuste de altura de patas patentado (151/181cm)





▶ Play













pg. 53 **Ricambi**
→ Spare parts
Recambios

F1-101

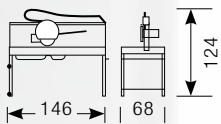

F1-131

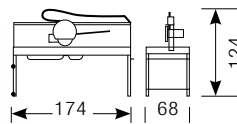



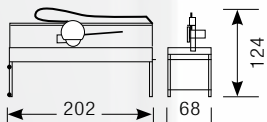

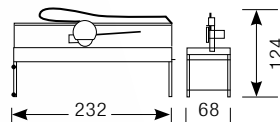

F1-151



F1-181



| Art. |  |  | |  | |  | |  | |  |  |
|-------------|---|---|------|---|-------------|---|-------------|--|--------|---|---|
| | | cm | inch | cm | inch | max cm | max inch | mm | inch | | |
| F1-101 | 230V~/2,2kW (3HP) 50Hz/2.800rpm | 101 | 40 | 71 x 71 | 28 x 28 | 5 | 2 | 250/25,4 | 10 / 1 | 75 | C/1 |
| F1-131 | 230V~/2,2kW (3HP) 50Hz/2.800rpm | 131 | 51,5 | 92 x 92 | 36 x 36 | 5 | 2 | 250/25,4 | 10 / 1 | 85 | C/1 |
| F1-151 | 230V~/2,2kW (3HP) 50Hz/2.800rpm | 151 | 59,5 | 106 x 106 | 41,5 x 41,5 | 5 | 2 | 250/25,4 | 10 / 1 | 100 | C/1 |
| F1-181 | 230V~/2,2kW (3HP) 50Hz/2.800rpm | 181 | 71,5 | 128 x 128 | 50 x 50 | 5 | 2 | 250/25,4 | 10 / 1 | 112 | C/1 |
| F1-101-115V | 115V~/1,5kW (2HP) 60Hz/3.360rpm | 101 | 40 | 71 x 71 | 28 x 28 | 5 | 2 | 250/25,4 | 10 / 1 | 75 | C/1 |
| F1-131-115V | 115V~/1,5kW (2HP) 60Hz/3.360rpm | 131 | 51,5 | 92 x 92 | 36 x 36 | 5 | 2 | 250/25,4 | 10 / 1 | 85 | C/1 |
| F1-151-115V | 115V~/1,5kW (2HP) 60Hz/3.360rpm | 151 | 59,5 | 106 x 106 | 41,5 x 41,5 | 5 | 2 | 250/25,4 | 10 / 1 | 100 | C/1 |
| F1-181-115V | 115V~/1,5kW (2HP) 60Hz/3.360rpm | 181 | 71,5 | 128 x 128 | 50 x 50 | 5 | 2 | 250/25,4 | 10 / 1 | 112 | C/1 |

OPTIONALS



Art. 58E

- IT** Tappetino in gomma per mosaico, piastrelle in vetro, delicate o sottili (3mm).
- GB** Rubber pad for mosaic tiles, delicate and very thin 3mm glass tiles.
- ES** Alfombra de goma para mosaicos, baldosas de vidrio, delicadas y finas (3 mm).



Art. 1051

- IT** Tavolino di supporto
- GB** Support table.
- ES** Mesa de soporte



Art. 1305F1

Standard su art. F1-181
Standard on art. F1-181
Norma sobre el art. F1-181

- IT** Kit avanzamento con volantino - sistema che fornisce prestazioni di taglio senza sforzo e facile.
- GB** Hand Wheel Feed Kit - a System that provides effortless & easy cutting performance.
- ES** Arrastre con manivela - un sistema que permite cortes fáciles y sin fatiga



Art. 1198F1

- IT** Contrasto di precisione per taglio o jolly ripetitivi.
- GB** Precision side square for repetitive cuts or jolly.
- ES** Escuadra lateral de precisión para cortes repetitivos o jinglete.

F2

IT Taglierina elettrica ad acqua.
 GB Electric, water-cooled diamond tile saws.
 ES Cortadora eléctrica con agua.



Piano di lavoro in acciaio inox
 Stainless steel worktop
 Plano de trabajo de acero inox

Art. CE
 Disco diamantato incluso
 Diamond blade included
 Disco diamantado incluido

ABS antiurto
 ABS shockproof
 ABS anti impacto



pg. 53 Ricambi
 Spare parts
 Recambios

| Art. | | | | | | | | | | |
|---------|---|--------------------------------------|---------|-------|--------|----------|----------|-------|-----|-----|
| | | | cm | inch | max cm | max inch | mm | inch | | |
| 905EV02 | 230V~ / 0,45kW (0,6HP) 50Hz / 2.800rpm | Illimitato Unlimited Ilimitado | 15 x 15 | 6 x 6 | 3,5 | 1-3/8 | 180/25,4 | 7 / 1 | 7,1 | S/1 |
| 906EV02 | 115V~ / 0,4kW (0,55HP) 50-60Hz / 2.800-3360rpm | Illimitato Unlimited Ilimitado | 15 x 15 | 6 x 6 | 3,5 | 1-3/8 | 180/25,4 | 7 / 1 | 7,1 | S/1 |

BIMBO FORATUTTO



- IT Elettroforatrice ad acqua per frese diamantate.
- GB Electric water-cooled corebit drills.
- ES Perforadora eléctrica con agua para fresadoras diamantadas.



pg. 93 → Frese diamantate non incluse
 Diamond cutters not included
 Fresadoras diamantada no incluidas

pg. 53 → Ricambi
 Spare parts
 Recambios























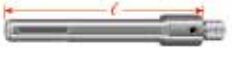









| Art. | | | | | | | | |
|------|-------------------------------------|------------------------|--------|----------|--------|----------|----|-----|
| | | | max mm | max inch | max cm | max inch | | |
| 915 | 230V~ / 0,4kW (0,55HP) 1.400 rpm | M16 Optional: W5/8" | 120 | 4-3/4 | 3,5 | 1-3/4 | 17 | C/1 |
| 916 | 115V~ / 0,4kW (0,55HP) 1.400 rpm | M16 Optional: W5/8" | 120 | 4-3/4 | 3,5 | 1-3/4 | 17 | C/1 |

ACCESSORI PER LA FORATURA AD ACQUA

EQUIPMENT FOR WET DRILLING - EQUIPOS PARA LA PERFORACIÓN CON AGUA

| | | |
|------------|---|--|
| Art. PS92 | Raccordo portapunta per MU (x artt. 915/916/CVG12) Drill-holder connector for MU (x artt. 915/916/CVG12) Enganche portapunta MU (x artt. 915/916/CVG12) | |
| Art. AUFA | Raccordo per trapano - M16 (x artt. FA/FAV) Adapter for drill - M16 (x artt. FA/FAV) Adaptador para taladro - M16 (x artt. FA/FAV) | |
| Art. 88 | Mandrino a punta centrale retraente - M16 (x artt. FA/FAV) Arbor with central retractable bit - M16 (x artt. FA/FAV) Mandril con punta central retráctil - M16 (x artt. FA/FAV) | |
| Art. CVG12 | Convogliatore d'acqua completo di tanica Water feed complete with jerry Depósito de agua con bidón | |
| Art. VTKIT | Ventose per foratura con acqua (Ø 40mm + Ø 60mm) Suction cups for water drilling (Ø 40mm + Ø 60mm) Ventosas para perforación con agua (Ø 40mm + Ø 60mm) | |
| Art. 89 | Riduzione M16 - G 1/2" M16 - G 1/2" adapter Adaptador M16 - G 1/2" | |

IT Accessori per foretti diamantati a settori.
 GB Fittings for segmented diamond core-drills.
 ES Accesorios para coronas diamantadas de segmentos.

| Art. | mm | inch | e | | |
|-----------|---|------|---------|--|---|
| | | | | | |
| AM16F | G 1/2"  M16 | | | |  |
| AM16M | G 1/2"  M16 | | | |  |
| AM16F18 | M18  M16 | | | |  |
| MT-AU80 |  Ø 12mm  M16 NICHEL-CROMO-MOLIBDENO | 80 | 3-1/4 | |  |
| MT-AU230 | | 230 | 9 | | |
| MT-AS80 |  SDS PLUS  M16 NICHEL-CROMO-MOLIBDENO | 80 | 3-1/4 | |  |
| MT-AS230 | | 230 | 9 | | |
| MT-ASMAX |  SDS MAX  M16 NICHEL-CROMO-MOLIBDENO | 170 | 6-11/16 | |  |
| M-PC240 | attacco conico conical connection conexión cónica  Ø 10mm x artt. M-AU80 · M-AU180 · M-AU280 · M-AS100 · M-AS180 · M-AS280 · M-ASMAX | 240 | 9,5 | |  |
| MT-PC220 |  x artt. MT-AU80 · MT-AU230 · MT-AS80 · MT-AS230 · MT-ASMAX | 220 | 8-5/8 | |  |
| PCFUXL | solo x mod. FUXL e carotatrici mod. EM  only for mod. FUXL and core drills mod. EM Sólo para mod. FUXL y taladradora mod. EM | 400 | 16 | |  |
| PCFX | solo x mod. FX e carotatrici mod. EM  only for mod. FX and core drills mod. EM Sólo para mod. FX y taladradora mod. EM | 550 | 21-1/2 | |  |
| MT-PR200 |  M16  M16 NICHEL-CROMO-MOLIBDENO x mod. FUTS - FUXT | 250 | 10 | |  |
| M-PR-W100 | con passaggio aspirazione/liquidi  1" 1/4  1" 1/4 | 100 | 4 | |  |
| M-PR-W200 |  1" 1/4  1" 1/4 | 200 | 8 | | |
| M-PR-W500 | with air/fluid gateway con paso de succión/líquido  1" 1/4  1" 1/4 | 500 | 20 | | |

CORE EM

- IT Carotatrici professionali con accessori.
- GB Professional core drilling machines with accessories.
- ES Taladradora de diamante profesional con accesorios.



Art. EM18W



| Art. | | | | UTILIZZI / USE / USAR | | |
|--------|---|--------|------------------------|-----------------------|------|-----|
| | | max mm | | | kg | BOX |
| EM18W | 230V~/1,8kW (2,46HP) 1000/2600 rpm | 180 | M16 1/2"gas -1-1/4" | + + | 7,3 | C/1 |
| EM25W* | 230V~/2,5kW (3,35HP) 310/450/960 rpm | 250 | 1/2"gas -1-1/4" | | 11,5 | C/1 |
| EM33W* | 230V~/3,3kW (4,49HP) 230/510/730 rpm | 350 | 1/2"gas -1-1/4" | | 12,5 | C/1 |

* A richiesta - On request - A pedido

- IT Supporto per carotatrici.
- GB Support for core drilling machines.
- ES Soportes para taladros.



| Art. | | | | | | | |
|--------|----------|--------------|--------|-----|---|----|-----|
| | | suggested mm | max mm | mm | | kg | BOX |
| EMB13 | 0° ÷ 45° | 200 | 250 | 580 | Attacco con collare Ø 60 mm incluso Connection with Ø 60mm collar included Conexión con collar Ø 60mm incluido | 13 | C/1 |
| EMB16* | 0° ÷ 45° | 300 | 400 | 610 | Attacco rapido - Collare Ø 60mm optional Quick connection - Ø 60mm collar optional Conexión rápido - Collar Ø 60mm opcional | 18 | C/1 |
| EMB32* | 0° ÷ 45° | 350 | 600 | 650 | Attacco rapido - Collare Ø 60mm optional Quick connection - Ø 60mm collar optional Conexión rápido - Collar Ø 60mm opcional | 19 | C/1 |

* A richiesta - On request - A pedido

CRAB



- IT Tenaglia professionale per piastrellista speciale per gres porcellanato.
- GB Professional nibbler for porcelain stoneware specifically designed for tilers.
- ES Tenaza profesional para soladores especial para gres porcelánico.

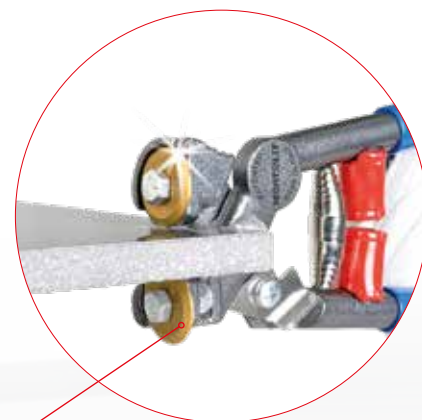

| | | |
|------|----------|-----|
| Art. | | |
| 33W | g 430 | S/6 |

 [Play](#)

Art. 242TW

54

- Art. 54 IT Tenaglia per piastrellista a branche incisive regolabili.
- GB Tile nibbler with adjustable cutting jaw.
- ES Tenaza para solador con dientes incisivos regulables.

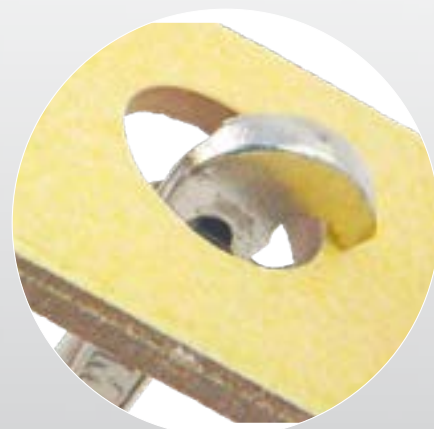

MOSAIC





- IT** Tenaglia professionale per mosaico ceramico e vetroso.
- GB** Professional nibbler for ceramic and glass mosaic.
- ES** Tenaza profesional para mosaico de cerámica y vidrio.





Art. 242TW

| Art. |  g |  BOX |
|------|---|---|
| 55W2 | 380 | S/6 |



▶ Play













56RJ

- Art. 56RJ**
- IT** Doppio sistema di spacco Max 15mm.
- GB** Dual splitting system Max 15mm.
- ES** Doble sistema de separación Max 15mm.





56R

- Art. 56R**
- IT** Doppio sistema di spacco Max 20mm.
- GB** Dual splitting system Max 20mm.
- ES** Doble sistema de separación Max 20mm.



VENTOSA



- IT Ventosa per piastrellista.
GB Sucker for tile-layer.
ES Ventosa para montador de baldosas.

| Art. |  mm |  kg |  |
|--------|--|--|---|
| 300-76 | 200 | 1,250 | C/1 |



GECO

- IT Ventosa per piastrellista.
GB Suckers for tile-layer.
ES Ventosas para montador de baldosas.

| Art. |  mm |  kg |  |
|------|--|--|---|
| GECO | 220 | 1,100 | C/1 |



VT80

- IT Ventosa per piastrellista.
GB Suckers for tile-layer.
ES Ventosas para montador de baldosas.

| Art. |  mm |  |
|-------|--|---|
| VT-80 | 80 | B/1 |





MONTHOR



**SPECIAL RED RUBBER
NO STAMP**



- IT** Mazzette in gomma ideali per ogni tipo di ceramica delicata/sottile e gres porcellanato.
- GB** Rubber mallets designed for any kind of thin ceramic and gres porcelain.
- ES** Mazas de goma ideales para todo tipo de cerámica tanto delicada y fina como para porcelánico.

| Art. |  |  |
|-------------|---|---|
| MONTHOR500 | 500 | S/4 |
| MONTHOR1000 | 1.000 | S/4 |





▶ Play 



16-S

- IT** Sollevalastre per alto spessore e superficie strutturata.
- GB** Handle lift slabs for high thickness and with a structured surface.
- ES** Manija de elevación de losas de gran formato, espesor alto y con superficie estructurada.



| Art. |  |  |  |
|------|---|---|---|
| 16-S | 50 ÷ 65 | 20 ÷ 25 -3/4 | C/2 |

25V

- IT** Cutter per vetro/piastrelle/lastre sottili.
- GB** Cutter for glass/ceramic/large formats.
- ES** Cúter para vidrio/baldosas/losas finas.



| Art. |  |
|------|---|
| 25V | B/1 |

MONTHOR 2000

- IT Mazza per blocchi / autobloccanti.
- GB Hammer for blocks and keyblock material.
- ES Martillo para bloques/ autobloqueantes.

Art. MT-24

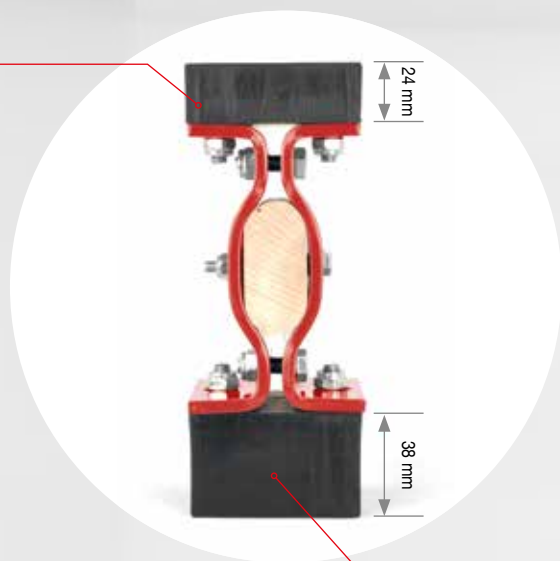

Art. MT-38

| Art. | | |
|-------------|-------|-----|
| MONTHOR2000 | 2.000 | V/1 |

PINZONE

- IT Pinza di sollevamento per cordoli.
- GB Kerb stone handle.
- ES Pinza de elevación para bordillos.



| Art. | | Portata Max Max load | | |
|------|-----------|-------------------------|----|-----|
| | cm | kg | kg | |
| 16 | 5 ÷ 18 | 200 | 11 | C/1 |
| | inch. | | | |
| | 2 ÷ 7 1/2 | | | |

TAGLIATEGOLE

- IT Tagliategole per tegole in cemento e cotto.
- GB Roof tile cutters for clay roof tiles and concrete.
- ES Cortadora de tejas para tejas de arcilla y hormigón.



| Art. | | |
|------|---|-----|
| 42 | 7 | C/1 |

BLOCKUT



IT Tranciblocchi.
 GB Paving block cutter.
 ES Cortadora de autobloqueantes.



pg. 52 → Ricambi
 Spare parts
 Recambios

| Art. | cm | inch. | cm | inch. | kg | kg | BOX |
|---------|----|-------|--------|-------------|-------|----|-----|
| BLOCKUT | 33 | 13 | 2 ÷ 11 | 3/4 ÷ 4-3/8 | 4.100 | 28 | C/1 |

X-WORKS



IT Banco di lavoro per piastrellista.
 GB Work-table for tile installer.
 ES Banco de trabajo para solador.

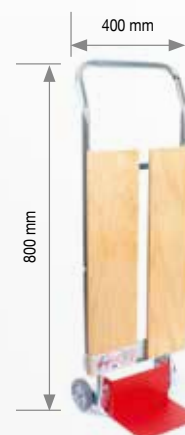
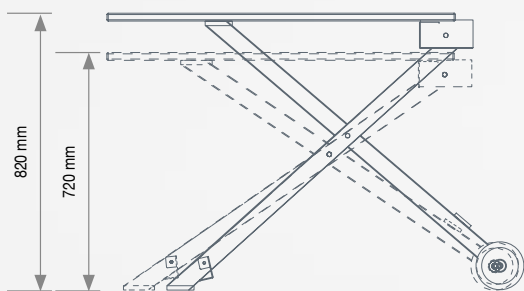

| Art. | kg | BOX |
|---------|----|-----|
| X-WORKS | 18 | C/1 |

| | | |  |  |
|---|-----------|---|--|---|
| | Art. |  | FLASH LINE - FL3 | BLOCKUT |
|  | 240T | B/1 | ✓ | |
|  | 241T | S/12 | ✓ | |
|  | 242T-FL3 | B/1 | ✓ | |
|  | FL3-04 | B/1 | ✓ | |
|  | FL3-03 | S/1 | ✓ | |
|  | 56RJ | S/1 | ✓ | |
|  | 300-FL-02 | S/1 | ✓ | |
|  | FL3-02 | S/1 | ✓ | |
|  | FL3-01 | S/1 | ✓ | |
|  | 208BC | V/1 | | ✓ |
|  | 209BC | V/1 | | ✓ |
|  | 302 | V/1 | | ✓ |

| | | |  |  |  |  |
|---|--------------|---|---|--|---|---|
| | Art. |  | BATTILE | BATTILE PRO | BATTILONE | GECONE e-power |
|  | BTL-03 | V/1 | ✓ | | | |
| | BTL-P-06 | V/1 | | ✓ | | |
| | BATTILONE-02 | V/1 | | | ✓ | |
|  | BTL-01 | S/1 | ✓ | | | |
| | BTL-P-08 | S/1 | | ✓ | | |
| | BATTILONE-07 | S/1 | | | ✓ | |
|  | GECONE-08 | V/1 | | | | ✓ |
| | BTL-P-04 | V/1 | | ✓ | | |
| | BATTILONE-01 | V/1 | | | ✓ | |
|  | GECONE-01 | V/1 | | | | ✓ |
| | GECONE-02 | V/1 | | | | ✓ |
| | GECONE-03 | V/1 | | | | ✓ |
|  | GECONE-04 | V/1 | | | | ✓ |
| | BTL-02 | B/1 | ✓ | | | |
| | BTL-09 | V/1 | ✓ | | | |
|  | BTL-P-11 | V/1 | | ✓ | | |
| | BATTILONE-08 | V/1 | | | ✓ | |
| | GECONE-09 | V/1 | | | | ✓ |

| | | | |  | | | |  | | | |  | | | |
|---|----------|---|--|---|--------|--------|--------|---|-------------|-----------------|-------------|---|--------------------|-----|----------------|
| | | | | F1 BROOKLYN | | | | F2 | | BIMBO FORATUTTO | | | | | |
| | Art. |  | | F1-101 | F1-131 | F1-151 | F1-181 | F1-101-115V | F1-131-115V | F1-151-115V | F1-161-115V | 905EV02 | 906EV02 (115V~) | 915 | 916 (115V~) |
|  | 1080MB | V/1 | | ✓ | ✓ | ✓ | ✓ | | | | | | | | |
| | 1081MB | V/1 | | | | | | ✓ | ✓ | ✓ | ✓ | | | | |
| | 1092EV02 | V/1 | | | | | | | | | | ✓ | | | |
| | 1093EV02 | V/1 | | | | | | | | | | | ✓ | | |
| | 1075 | V/1 | | | | | | | | | | | | ✓ | |
| | 1076 | V/1 | | | | | | | | | | | | | ✓ |
|  | 1082 | V/1 | | ✓ | ✓ | | | | | | | | | | |
| | 1082F1 | V/1 | | | | ✓ | ✓ | | | | | | | | |
| | 1083 | V/1 | | | | | | ✓ | ✓ | | | | | | |
| | 1083F1 | V/1 | | | | | | | | ✓ | ✓ | | | | |
|  | 1191 | V/1 | | ✓ | ✓ | ✓ | ✓ | | | | | | | | |
| | 1155 | V/1 | | | | | | ✓ | ✓ | ✓ | ✓ | | | | |
| | 1096EV02 | V/1 | | | | | | | | | | ✓ | | | |
| | 1097EV02 | V/1 | | | | | | | | | | | ✓ | | |
| | 1053 | V/1 | | | | | | | | | | | | ✓ | |
| | 1054 | V/1 | | | | | | | | | | | | | ✓ |
|  | 1077 | V/1 | | | | | | | | | | | | ✓ | |
| | 1079 | V/1 | | | | | | | | | | | | | ✓ |
|  | 1206F1 | V/1 | | ✓ | ✓ | ✓ | ✓ | ✓ | ✓ | ✓ | ✓ | | | | |
|  | 1208F1 | V/1 | | ✓ | ✓ | ✓ | ✓ | ✓ | ✓ | ✓ | ✓ | | | | |
|  | 1110EV02 | V/1 | | | | | | | | | | ✓ | ✓ | | |
|  | 1195 | V/1 | | ✓ | ✓ | ✓ | ✓ | ✓ | ✓ | ✓ | ✓ | | | | |
|  | 1095F1SX | V/1 | | ✓ | ✓ | ✓ | ✓ | ✓ | ✓ | ✓ | ✓ | | | | |
| | 1095F1DX | V/1 | | ✓ | ✓ | ✓ | ✓ | ✓ | ✓ | ✓ | ✓ | | | | |
|  | 1089EV | V/1 | | ✓ | ✓ | | | ✓ | ✓ | | | | | | |
| | 1198EV | V/1 | | | | ✓ | ✓ | | | | ✓ | ✓ | | | |
|  | 1113EV02 | V/1 | | | | | | | | | | ✓ | ✓ | | |
|  | 1114EV02 | V/1 | | | | | | | | | | ✓ | ✓ | | |
|  | 1073EV | V/1 | | ✓ | ✓ | ✓ | ✓ | ✓ | ✓ | ✓ | ✓ | | | | |
|  | 1201 | S/1 | | ✓ | ✓ | ✓ | ✓ | ✓ | ✓ | ✓ | ✓ | | | | |
|  | 302F1 | V/1 | | ✓ | ✓ | ✓ | ✓ | ✓ | ✓ | ✓ | ✓ | | | | |
|  | 1072 | V/1 | | | | | | | | | | | | ✓ | ✓ |

LAMA UNIVERSALE PER LEGNO



- IT Lame circolari universali per legno.
- GB Universal circular blades for timber.
- ES Cuchillas circulares universal para madera.

| Art. | | | mm | N° | mm | |
|------|-----|------|---------|----|-----|-----|
| | mm | inch | | | | |
| 813 | 315 | 12,5 | 30/25,4 | 48 | 3,2 | S/1 |
| 814 | 350 | 14 | 35/25,4 | 54 | 3,4 | S/1 |

WOOD CARVER



- IT Lame circolari per legno.
- GB Circular blades for timber.
- ES Cuchillas circulares para madera.

| Art. | | | mm | N° | |
|-------|-----|------|------|----|-----|
| | mm | inch | | | |
| 115LL | 115 | 4,5 | 22,2 | 6 | B/1 |
| 230LL | 230 | 9 | 22,2 | 48 | B/1 |

ATTENZIONE!

Verificare che l'utensile sia compatibile con la macchina sulla quale verrà montato consultandone il manuale d'uso e di sicurezza.

ATTENTION!

Check that this blade is compatible with the machines to which it will be assembled consulting their instructions and safety handbooks.

¡ATENCIÓN!

Comprobar que la herramienta sea compatible con la máquina sobre la cuál será montada consultando el manual de uso y de seguridad.

GRATTINO



- IT Disco per sbavatura e levigatura ideale per cartongesso, legno e plastica.
- GB Disc for grinding suitable for plasterboard, wood and plastic material.
- ES Disco para alisado y pulido ideal para cartón piedra, madera y plástico.

| Art. | | | mm | |
|-------|-----|------|------|-----|
| | mm | inch | | |
| 115GL | 115 | 4,5 | 22,2 | B/1 |

ATTENZIONE!

Verificare che l'utensile sia compatibile con la macchina sulla quale verrà montato consultandone il manuale d'uso e di sicurezza.

ATTENTION!

Check that this blade is compatible with the machines to which it will be assembled consulting their instructions and safety handbooks.

¡ATENCIÓN!

Comprobar que la herramienta sea compatible con la máquina sobre la cuál será montada consultando el manual de uso y de seguridad.

TUTORCUT-U



- IT Guida assistita per tagli perfetti.
- GB Assisted guide for perfect cuts.
- ES Guía asistida para cortes perfectos.



Poliamide antitraccia resistente all'usura.
Wear-resistant, non-marking polyamide.
Poliamida que no deja rastro resistente al desgaste.

Adatto alle più comuni smerigliatrici.
Suitable for the most common grinders.
Se adapta a las amoladoras más comunes



Rotazioni disco/TutorCut differenziate e indipendenti.
Differentiated and independent disc/TutorCut rotations.
Rotaciones del disco/TutorCut diferenciadas e independientes.

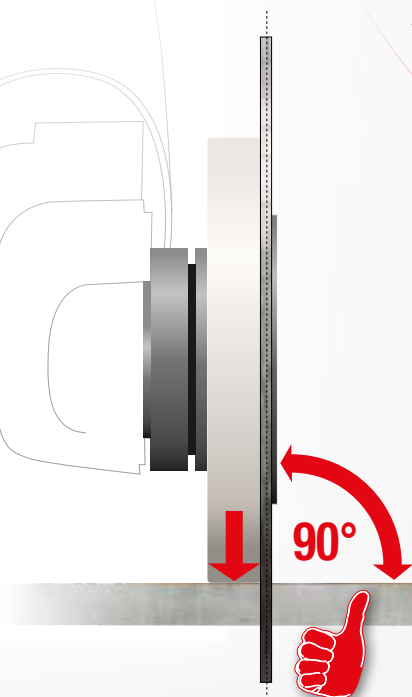

Cuscinetto a sfere ermetico
Hermetically sealed ball bearing.
Cojinete de esferas hermético.



Art.



| | | | | |
|------------------|-----------|--------|------|-----|
| TUTORCUT115-U | x Ø 115mm | Ø 14mm | 20mm | B/1 |
| TUTORCUT125-U | x Ø 125mm | Ø 14mm | 20mm | B/1 |
| TUTORCUT115-U-16 | x Ø 4,5" | Ø 5/8" | 3/4" | B/1 |
| TUTORCUT125-U-16 | x Ø 5" | Ø 5/8" | 3/4" | B/1 |



DNA EVO3

DIAMONDS NETWORK ARRANGEMENT

+100% PERFORMANCE*

+30% SPEED*

+20/50% LIFE*

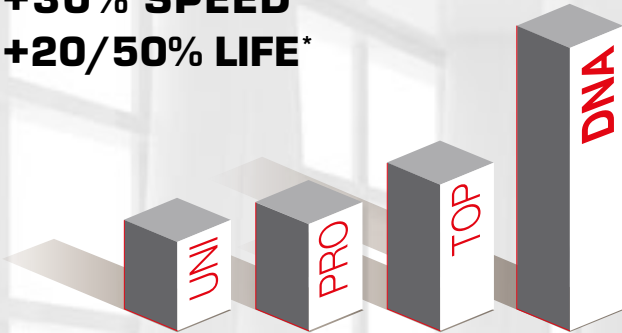

* Test eseguiti su dischi diamantati Brevetti Montolit
* Tests made on Brevetti Montolit diamond tools
* Test realizados en discos diamantados Brevetti Montolit

DNA è una innovativa tecnologia che consiste nella particolare “distribuzione a rete variabile e tridimensionale controllata” dei granuli di diamante contenuti all’interno della parte tagliente degli utensili. Si posizionano le singole grane di diamante a piacimento a secondo del progetto. Con DNA i settori diamantati e comunque tutte le parti taglienti sinterizzate dell’utensile, contenendo la stessa e predefinita quantità di granuli distribuiti con micrometrica precisione, presentano le medesime caratteristiche ottimali espressamente progettate per l’ottenimento delle migliori performances.

DNA Montolit is a revolutionary High Technology system of variable diamond particles that gives the installer the perfect cut every time. The diamonds have been positioned in a Three-dimensional structure which means that when the top layer is worn, the next layer is ready to perform to the same high performance. This is the Montolit DNA standard.

DNA es una innovación tecnológica que consiste en su particular distribución con red variable e tridimensional controlada de los granulos de diamante contenidos en el interior de la parte cortante de las herramientas. Se podrán después “disponer” los granos individuales de diamante a placer según lo proyecto. Con DNA las partes diamantadas y por lo tanto todas aquellas partes cortantes sintetizadas de la herramienta, conteniendo la misma y predefinida cantidad de granulos distribuidos con una precisión micrométrica, presentan las mismas características expresamente proyectadas para la obtención de los mejores resultados.

Particolare distribuzione con reticolo variabile e tridimensionale controllato di granuli di diamante.
Particular distribution with controlled variable and three-dimensional network of diamond granules.
Particular distribución con red variable e tridimensional controlada de los granulos de diamante.



MONTOLIT®

Dischi diamantati
Diamond blades
Discos diamantados



SCX - SEGMENTS

DNA EVO3

Gres porcellanato/Ceramica "PRO"/Granito
Porcelain stoneware/Ceramic "Pro"/Granite
Gres porcelánico/Cerámica "Pro"/Granito

GOLD LINE
"HIGH TECHNOLOGY"



| | | |
|------------------------------|--------------------------|--------------------------------|
| Velocità - Speed - Velocidad | Durata - Life - Duración | Finitura - Finishing - Acabado |
| ★★★★ | ★★★★ | ★★★★☆ |

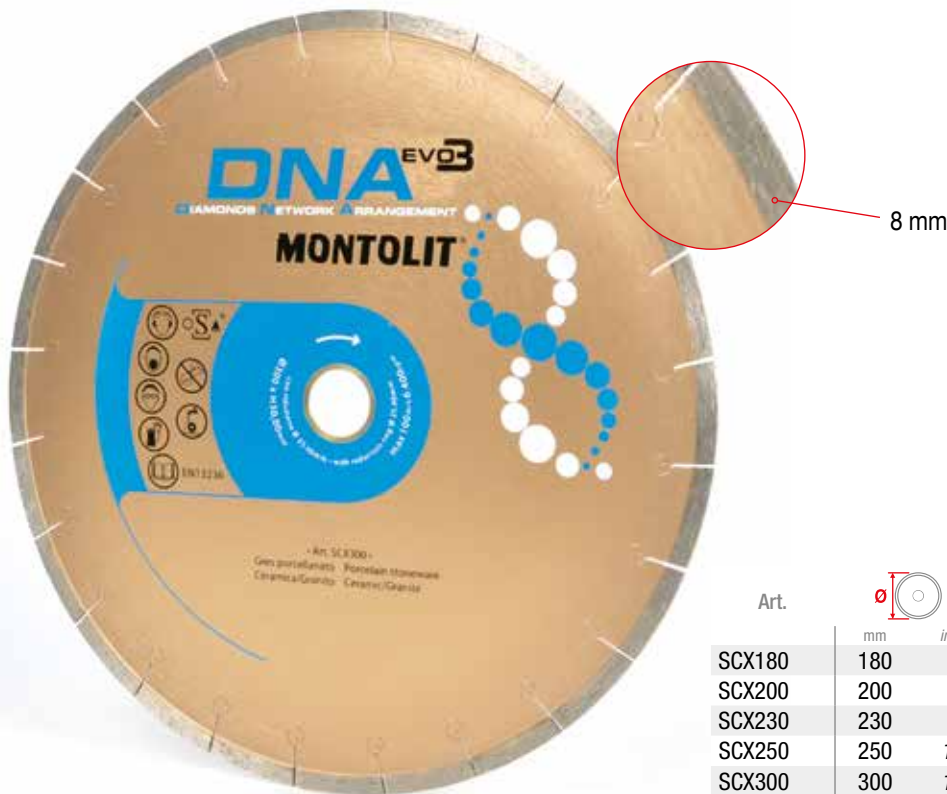

| Art. | Ø | | Ø | | Ø | |
|-----------|-----|------|-----------|-----|----|----|
| | mm | inch | mm* | mm | mm | mm |
| SCX180 | 180 | 7 | 25,4/22,2 | 2,0 | | |
| SCX200 | 200 | 8 | 30/25,4 | 2,0 | | |
| SCX230 | 230 | 9 | 30/25,4 | 2,2 | | |
| SCX250 | 250 | 10 | 30/25,4 | 2,2 | | |
| SCX300 | 300 | 12 | 30/25,4 | 2,4 | | |
| SCX350 | 350 | 14 | 30/25,4 | 2,4 | | |
| SCX350/60 | 350 | 14 | 60/50 | 2,4 | | |
| SCX400 | 400 | 16 | 60/50 | 3,2 | | |

* 5/8 inch: Riduzione a richiesta • Reduction on request • Reducción a pedido

| IT | GB | ES | |
|---|---|--|-------|
| Gres porcellanato | Porcelain stoneware | Gres porcelánico | ★★★★★ |
| Piastrelle in monocottura, klinker, cotto | Single-fired ceramic tiles, klinker, terracotta | Baldosas de cerámica, klinker, terracota | ★★★★★ |
| Piastrelle in granito e pietre dure | Granite tiles and hard stone | Baldosas de granito y piedras duras | ★★★★★ |
| Piastrelle in marmo | Marble tile | Baldosas de mármol | ★★★★☆ |
| Piastrelle in bicottura | Double fired glazed tile | Baldosas de doble cocción | ★★★☆☆ |

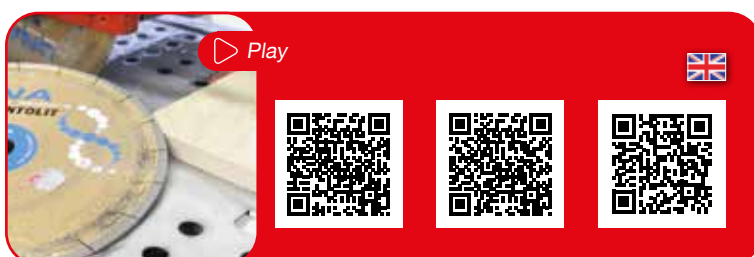

SCX-S - SEGMENTS

DNA EVO3

Gres porcellanato/Gres porcellanato spessorato/
Granito ceramico
Porcelain stoneware/Porcelain stoneware high thickness/
Ceramic granite
Gres porcelánico/Gres porcelánico de gran espesor/Granito
de cerámica

GOLD LINE
"HIGH TECHNOLOGY"



Speciale per gres porcellanato alto spessore
Special for porcelain stoneware high thickness
Especial para gres porcelánico de alto espesor.

| | | |
|------------------------------|--------------------------|--------------------------------|
| Velocità - Speed - Velocidad | Durata - Life - Duración | Finitura - Finishing - Acabado |
| ★★★★★ | ★★★★★ | ★★★★☆ |

| Art. | | | | | | |
|--------------|-----|------|---------|-----|----|----|
| | mm | inch | mm * | mm | mm | mm |
| SCXS-T200 | 200 | 8 | 30/25,4 | 2,0 | | |
| SCXS-T250 | 250 | 10 | 30/25,4 | 2,2 | | |
| SCXS-T300 | 300 | 12 | 30/25,4 | 2,4 | | |
| SCXS-T350 | 350 | 14 | 30/25,4 | 2,4 | | |
| SCXS-T350/60 | 350 | 14 | 60/50 | 2,4 | | |
| SCXS-T400 | 400 | 16 | 60/50 | 3,2 | | |

* 5/8 inch: Riduzione a richiesta • Reduction on request • Reducción a pedido

| IT | GB | ES | |
|--|--|--|-------|
| Gres porcellanato | Porcelain stoneware | Gres porcelánico | ★★★★★ |
| Gres porcellanato molto duro | Very hard porcelain stoneware | Gres porcelánico muy duro | ★★★★★ |
| Gres porcellanato, monocottura, klinker | Porcelain stoneware, Single-fired ceramic tiles, klinker | Gres porcelánico, monococción, klinker | ★★★★★ |
| Piastrelle in granito e pietre dure, cotto | Granite tiles and hard stone, terracotta | Baldosas de granito y piedras duras, terracota | ★★★★★ |
| Piastrelle in marmo | Marble tile | Baldosas de mármol | ★★★★☆ |

SCX-F - Sandwich Tech

NEW 2025

DNA EVO3

Gres porcellanato/Ceramica/Marmo/Granito
Porcelain stoneware/Ceramic/Marble/Granite
Gres porcelánico/Cerámica/Mármol/Granito

GOLD LINE
"HIGH TECHNOLOGY"



MONTOLIT

| Art. | | | | | | |
|-------------|-----|------|---------|-----|----|----|
| | mm | inch | mm * | mm | mm | mm |
| SCX-F250 | 250 | 10 | 30/25,4 | 2,2 | | |
| SCX-F300 | 300 | 12 | 30/25,4 | 2,4 | | |
| SCX-F350 | 350 | 14 | 30/25,4 | 2,4 | | |
| SCX-F350/60 | 350 | 14 | 60/50 | 2,4 | | |

* 5/8 inch: Riduzione a richiesta • Reduction on request • Reducción a pedido

| | | |
|------------------------------|--------------------------|--------------------------------|
| Velocità - Speed - Velocidad | Durata - Life - Duración | Finitura - Finishing - Acabado |
| ★★★★☆ | ★★★★☆ | ★★★★★ |

| IT | GB | ES | |
|---|---|---|-------|
| Gres porcellanato | Porcelain stoneware | Gres porcelánico | ★★★★★ |
| Gres porcellanato duro | Hard porcelain stoneware | Gres porcelánico duro | ★★★★☆ |
| Piastrelle in monocottura, klinker, cotto | Single-fired ceramic tiles, klinker, terracotta | Baldosas de cerámica, klinker, terracota | ★★★★★ |
| Piastrelle in granito, pietre dure, marmo | Granite tiles, hard stone and marble | Baldosas de granito, piedras duras y mármol | ★★★★★ |
| Piastrelle in bicottura | Double fired glazed tile | Baldosas de doble cocción | ★★★★☆ |

CBX - CONTINUOUS RIM

DNA EVO3

Gres porcellanato/Granito
Porcelain stoneware/Granite
Gres porcelánico/Granito



GOLD LINE
"HIGH TECHNOLOGY"



| | | |
|------------------------------|--------------------------|--------------------------------|
| Velocità - Speed - Velocidad | Durata - Life - Duración | Finitura - Finishing - Acabado |
| ★★★★★ | ★★★★★ | ★★★★☆ |

| Art. | Ø | | Ø | |
|----------|-----|------|-----------|-----|
| | mm | inch | mm* | mm |
| CBX100 * | 100 | 4 | 22,2/15,8 | 1,3 |
| CBX115 * | 115 | 4,5 | 22,2 | 1,3 |
| CBX125 * | 125 | 5 | 22,2 | 1,3 |
| CBX230 | 230 | 9 | 22,2 | 2,0 |

* 5/8 inch: Riduzione a richiesta • Reduction on request • Reducción a pedido

* **XLOCK**: A richiesta • On request • A pedido

| IT | GB | ES | |
|--|--|---|-------|
| Gres porcellanato, klinker, monocottura | Porcelain stoneware, klinker, single-fired ceramic | Gres porcelánico, klinker, cerámica | ★★★★★ |
| Piastrelle in granito e pietra naturale | Granite tiles and natural stone | Baldosas de granito y piedras naturales | ★★★★★ |
| Lastre sottili in gres porcellanato | Porcelain stoneware slim slabs | Losas finas de gres porcelánico | ★★★★☆ |
| Gres porcellanato alto spessore | Porcelain stoneware high thickness | Gres porcelánico de alto espesor | ★★★★☆ |
| Piastrelle in bicottura, piastrelle in marmo | Double fired glazed tile, marble tile | Baldosas de doble cocción, baldosas de mármol | ★★★★☆ |



TXH - TURBO

DNA EVO3

Granito/Pietre dure/Calcestruzzo/Edilizia/Gres porcellanato spessorato
Granite/Hard stone/Concrete/Building industry/Porcelain stoneware high thickness
Granito/Piedras duras/Hormigón/Construcción/Gres porcelánico de gran espesor



GOLD LINE
"HIGH TECHNOLOGY"



| | | |
|------------------------------|--------------------------|--------------------------------|
| Velocità - Speed - Velocidad | Durata - Life - Duración | Finitura - Finishing - Acabado |
| ★★★★☆ | ★★★★★ | ★★★★☆ |

| Art. | Ø | | Ø | |
|--------|-----|------|------|-----|
| | mm | inch | mm* | mm |
| TXH115 | 115 | 4,5 | 22,2 | 2,4 |
| TXH125 | 125 | 5 | 22,2 | 2,4 |
| TXH230 | 230 | 9 | 22,2 | 2,8 |

* 5/8 inch: Riduzione a richiesta • Reduction on request • Reducción a pedido

| IT | GB | ES | |
|--------------------------------------|--|--|-------|
| Tegole, laterizio, mattoni | Roof tiles, brick | Tejas, ladrillos. | ★★★★★ |
| Autobloccanti, arenaria, refrattario | Self-locking bricks, sandstone, refractory | Autobloqueantes, arenisca, refractario | ★★★★★ |
| Granito, pietra, porfido | Granite, stone, porphyry | Granito, piedra, pórfido | ★★★★★ |
| Gres porcellanato alto spessore | Porcelain stoneware high thickness | Gres porcelánico de alto espesor | ★★★★★ |
| Calcestruzzo, calcestruzzo armato | Concrete, reinforced concrete | Hormigón, hormigón armado | ★★★★☆ |
| Marmo, ceramica | Marble, ceramic | Mármol, cerámica | ★★★★☆ |



Speciale per gres porcellanato alto spessore
Special for porcelain stoneware high thickness
Especial para gres porcelánico de alto espesor

CGX - CONTINUOUS RIM

DNA EVO3

Gres porcellanato/Ceramica dura
Porcelain stoneware/Hard ceramic
Gres porcelánico/Cerámica dura



GOLD LINE
"HIGH TECHNOLOGY"

| | | |
|------------------------------|--------------------------|--------------------------------|
| Velocità - Speed - Velocidad | Durata - Life - Duración | Finitura - Finishing - Acabado |
| ★★★★ | ★★★★☆ | ★★★★☆ |



Super veloce
Superfast
Súper rápido

| Art. | Ø | | Ø | |
|--------|-----|------|-----------|-----|
| | mm | inch | mm* | mm |
| CGX100 | 100 | 4 | 22,2/15,8 | 1,3 |
| CGX115 | 115 | 4,5 | 22,2 | 1,3 |
| CGX125 | 125 | 5 | 22,2 | 1,3 |

* 5/8 inch: Riduzione a richiesta • Reduction on request • Reducción a pedido

| IT | GB | ES | |
|--|--|---|-------|
| Gres porcellanato, klinker, monocottura | Porcelain stoneware, klinker, single-fired ceramic | Gres porcelánico, klinker, cerámica | ★★★★★ |
| Piastrelle in granito e pietra naturale | Granite tiles and natural stone | Baldosas de granito y piedras naturales | ★★★★★ |
| Lastre sottili in gres porcellanato | Porcelain stoneware slim slabs | Losas finas de gres porcelánico | ★★★★☆ |
| Gres porcellanato alto spessore | Porcelain stoneware high thickness | Gres porcelánico de alto espesor | ★★★★☆ |
| Piastrelle delicate, piastrelle in marmo | Delicate tiles, marble tiles | Delicadas baldosas, baldosas de mármol | ★★★★☆ |

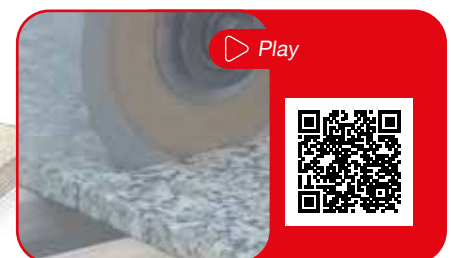

pg. 107 → Espositore
Display
Expositor

LX - LASER

DNA EVO3

Calcestruzzo/Edilizia/Granito/Pietre dure
Concrete/Building Industry/Granite/Porphyry/Hard stone
Hormigón/Construcción/Granito/Pórfido/Piedras duras

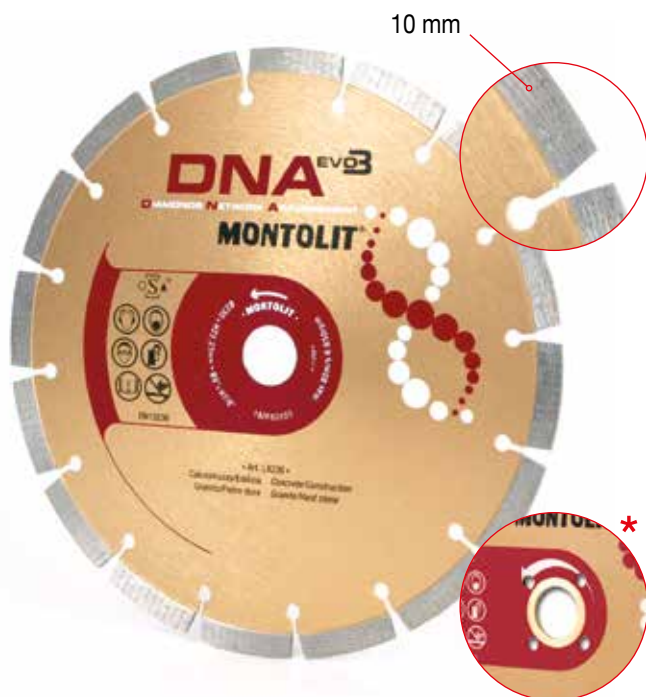

GOLD LINE
"HIGH TECHNOLOGY"

| Velocità - Speed - Velocidad | Durata - Life - Duración | Finitura - Finishing - Acabado |
|------------------------------|--------------------------|--------------------------------|
| ★★★★ | ★★★★☆ | ★★★☆☆ |

| Art. | Ø | | Ø | | |
|---------|-----|------|------|-----|--|
| | mm | inch | mm * | mm | |
| LX115 | 115 | 4,5 | 22,2 | 2,2 | |
| LX125 | 125 | 5 | 22,2 | 2,2 | |
| LX150 * | 150 | 6 | 22,2 | 2,2 | |
| LX180 * | 180 | 7 | 22,2 | 2,2 | |
| LX230 | 230 | 9 | 22,2 | 2,6 | |

* 5/8 inch: Riduzione a richiesta • Reduction on request • Reducción a pedido

* Ø 150 e 180 mm - 30/22,2mm: A richiesta • On request • A pedido

| IT | GB | ES | |
|-----------------------------|-------------------------------|---------------------------|-------|
| Calcestruzzo, autobloccanti | Concrete, self-locking bricks | Hormigón, autobloqueantes | ★★★★★ |
| Calcestruzzo armato | Reinforced concrete | Hormigón armado | ★★★★★ |
| Granito, pietra, porfido | Granite, stone, porphyry | Granito, piedra, pórfido | ★★★★★ |
| Tegole, laterizio, mattoni | Roof tiles, brick | Tejas, ladrillos. | ★★★★★ |
| Arenaria, refrattario | Sandstone, refractory | Arenisca, refractario | ★★★★☆ |

LXS - LASER SILENT

DNA EVO3

Calcestruzzo/Edilizia/Granito/Pietre dure
Concrete/Building Industry/Granite/Porphyry/Hard stone
Hormigón/Construcción/Granito/Pórfido/Piedras duras



GOLD LINE
"HIGH TECHNOLOGY"

| Velocità - Speed - Velocidad | Durata - Life - Duración | Finitura - Finishing - Acabado |
|------------------------------|--------------------------|--------------------------------|
| ★★★★★ | ★★★★☆ | ★★★☆☆ |

| Art. | Ø | | Ø | | |
|--------|-----|------|------|-----|--|
| | mm | inch | mm * | mm | |
| LXS230 | 230 | 9 | 22,2 | 2,6 | |

* 5/8 inch: Riduzione a richiesta • Reduction on request • Reducción a pedido

| IT | GB | ES | |
|-----------------------------|-------------------------------|---------------------------|-------|
| Calcestruzzo, autobloccanti | Concrete, self-locking bricks | Hormigón, autobloqueantes | ★★★★★ |
| Calcestruzzo armato | Reinforced concrete | Hormigón armado | ★★★★★ |
| Granito, pietra, porfido | Granite, stone, porphyry | Granito, piedra, pórfido | ★★★★★ |
| Tegole, laterizio, mattoni | Roof tiles, brick | Tejas, ladrillos. | ★★★★★ |
| Arenaria, refrattario | Sandstone, refractory | Arenisca, refractario | ★★★★☆ |

LX - LASER

DNA EVO3

Calcestruzzo/Edilizia/Granito/Pietre dure
Concrete/Building Industry/Granite/Porphry/Hard stone
Hormigón/Construcción/Granito/Pórfido/Piedras duras

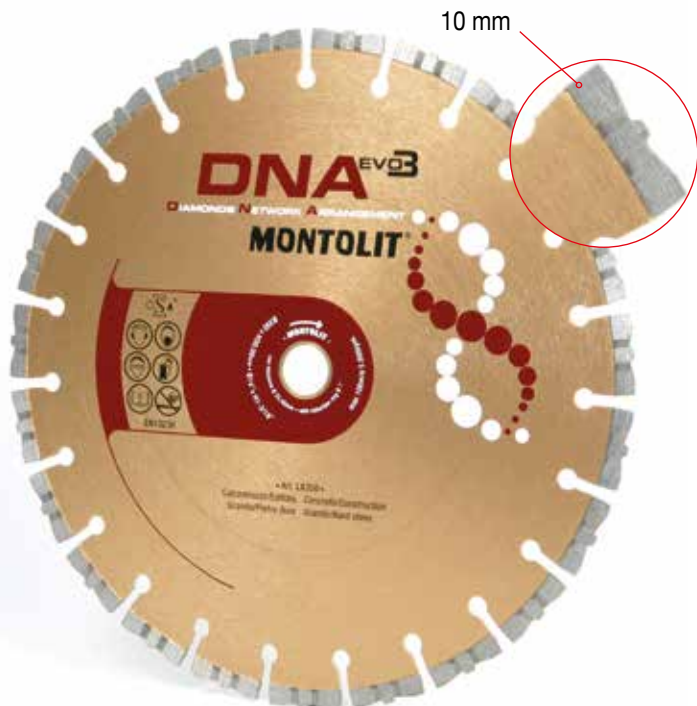

GOLD LINE
"HIGH TECHNOLOGY"

| Velocità - Speed - Velocidad | Durata - Life - Duración | Finitura - Finishing - Acabado |
|------------------------------|--------------------------|--------------------------------|
| ★★★★ | ★★☆☆ | ★★☆☆ |

| Art. | Ø | | Ø | | mm |
|-------|-----|------|------------|-----|----|
| | mm | inch | mm * | mm | |
| LX250 | 250 | 10 | 30/25,4 | 2,6 | |
| LX300 | 300 | 12 | 30/25,4 | 3,2 | |
| LX350 | 350 | 14 | 30/25,4 | 3,2 | |
| LX400 | 400 | 16 | 30/25,4 | 3,2 | |
| LX600 | 600 | 24 | 60/50/25,4 | 4,0 | |
| LX650 | 650 | 26 | 60/50/25,4 | 4,0 | |
| LX720 | 720 | 29 | 60/50/25,4 | 4,0 | |

* 5/8 inch: Riduzione a richiesta • Reduction on request • Reducción a pedido

| IT | GB | ES | |
|-----------------------------|-------------------------------|---------------------------|-------|
| Calcestruzzo armato | Reinforced concrete | Hormigón armado | ★★★★ |
| Tegole, laterizio, mattoni | Roof tiles, brick | Tejas, ladrillos. | ★★★★ |
| Calcestruzzo, autobloccanti | Concrete, self-locking bricks | Hormigón, autobloqueantes | ★★★★☆ |
| Granito, pietra, porfido | Granite, stone, porphyry | Granito, piedra, pórfido | ★★★★☆ |
| Arenaria, refrattario | Sandstone, refractory | Arenisca, refractario | ★★★☆☆ |

LXS - LASER SILENT

DNA EVO3

Calcestruzzo/Edilizia/Granito/Pietre dure
Concrete/Building Industry/Granite/Porphry/Hard stone
Hormigón/Construcción/Granito/Pórfido/Piedras duras



GOLD LINE
"HIGH TECHNOLOGY"

| Velocità - Speed - Velocidad | Durata - Life - Duración | Finitura - Finishing - Acabado |
|------------------------------|--------------------------|--------------------------------|
| ★★★★ | ★★☆☆ | ★★☆☆ |

| Art. | Ø | | Ø | | mm |
|--------|-----|------|---------|-----|----|
| | mm | inch | mm | mm | |
| LXS350 | 350 | 14 | 30/25,4 | 3,2 | |

| IT | GB | ES | |
|-----------------------------|-------------------------------|---------------------------|-------|
| Calcestruzzo armato | Reinforced concrete | Hormigón armado | ★★★★ |
| Tegole, laterizio, mattoni | Roof tiles, brick | Tejas, ladrillos. | ★★★★ |
| Calcestruzzo, autobloccanti | Concrete, self-locking bricks | Hormigón, autobloqueantes | ★★★★☆ |
| Granito, pietra, porfido | Granite, stone, porphyry | Granito, piedra, pórfido | ★★★★☆ |
| Arenaria, refrattario | Sandstone, refractory | Arenisca, refractario | ★★★☆☆ |

MONTOLIT

LXR - LASER

DNA EVO3

Calcestruzzo/Edilizia/Materiali abrasivi/Granito
Concrete/Building industry/Abrasive materials/Granite
Hormigón/Construcción/Materiales abrasivos/Granito



GOLD LINE
"HIGH TECHNOLOGY"

10 mm



| | |
|------------------------------|--------------------------|
| Velocità - Speed - Velocidad | Durata - Life - Duración |
| ★★★★ | ★★★★ |

| Art. | Ø | | Ø | |
|--------|-----|------|---------|-----|
| | mm | inch | mm | mm |
| LXR300 | 300 | 12 | 30/25,4 | 3,0 |
| LXR350 | 350 | 14 | 30/25,4 | 3,0 |
| LXR400 | 400 | 16 | 30/25,4 | 3,0 |

| IT | GB | ES | |
|--------------------------------------|--|----------------------------------|-------|
| Tegole in cemento, autobloccanti | Concrete roof tiles, self-locking bricks | Tejas de hormigón, autoblocantes | ★★★★ |
| Laterizio, mattoni, mattoni abrasivi | Brick, abrasive bricks | Ladrillos, ladrillos abrasivos | ★★★★ |
| Arenaria, lastre ghiaino lavato | Sandstone, washed gravel slabs | Arenisca, losas de grava lavada | ★★★★ |
| Calcestruzzo, calcestruzzo armato | Concrete, reinforced concrete | Hormigón, hormigón armado | ★★★★☆ |
| Granito, pietra, porfido | Granite, stone, porphyry | Granito, piedra, pórfido | ★★★☆☆ |

LXA - LASER

DNA EVO3

Calcestruzzo/Asfalto (Per macchine di bassa/media potenza - max 5kW)
Concrete/Asphalt (For low power machines - max 5kW)
Hormigón/Asfalto (Para máquinas de baja/ media potencia - max 5kW)



GOLD LINE
"HIGH TECHNOLOGY"

10 mm



| | |
|------------------------------|--------------------------|
| Velocità - Speed - Velocidad | Durata - Life - Duración |
| ★★★★ | ★★★★☆ |

| Art. | Ø | | Ø | |
|--------|-----|------|---------|-----|
| | mm | inch | mm | mm |
| LXA350 | 350 | 14 | 30/25,4 | 3,2 |
| LXA400 | 400 | 16 | 30/25,4 | 3,2 |
| LXA450 | 450 | 18 | 30/25,4 | 3,2 |

| IT | GB | ES | |
|---------------------------------------|--------------------------------|-------------------------------|-------|
| Asfalto | Asphalt | Asfalto | ★★★★ |
| Pavimentazione in calcestruzzo fresco | Green-mixed concrete floor saw | Pavimentos de hormigón fresco | ★★★★☆ |
| Pavimentazione in calcestruzzo | Concrete floor saw | Pavimentos de hormigón | ★★★☆☆ |

SX - LASER

DNA EVO3

Pavimenti in calcestruzzo stagionato
Concrete floor saw
Pavimentos de hormigón estacionado



GOLD LINE
"HIGH TECHNOLOGY"

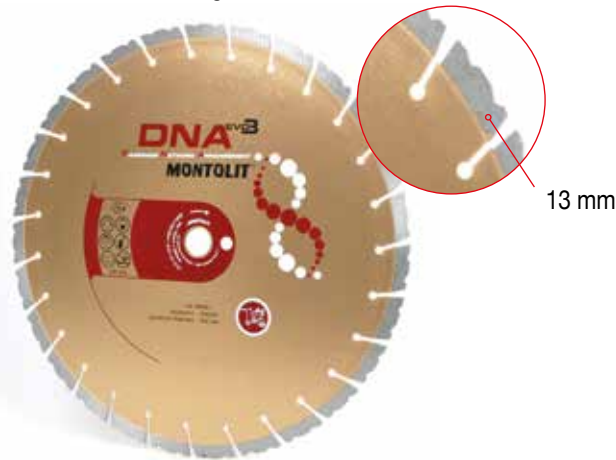

| | |
|------------------------------|--------------------------|
| Velocità - Speed - Velocidad | Durata - Life - Duración |
| ★★★★ | ★★★★ |

| Art. | Ø | | Ø | | |
|-------|-----|------|---------|-----|--|
| | mm | inch | mm | mm | |
| SX350 | 350 | 14 | 30/25,4 | 2,8 | |
| SX400 | 400 | 16 | 30/25,4 | 3,2 | |
| SX450 | 450 | 18 | 30/25,4 | 3,2 | |
| SX500 | 500 | 20 | 30/25,4 | 4,0 | |

SXF - LASER

DNA EVO3

Pavimenti in calcestruzzo fresco
Green-mixed concrete floor saw
Pavimentos de hormigón fresco



GOLD LINE
"HIGH TECHNOLOGY"



| | |
|------------------------------|--------------------------|
| Velocità - Speed - Velocidad | Durata - Life - Duración |
| ★★★★ | ★★★★☆ |

| Art. | Ø | | Ø | | |
|--------|-----|------|---------|-----|--|
| | mm | inch | mm | mm | |
| SXF350 | 350 | 14 | 30/25,4 | 3,2 | |
| SXF400 | 400 | 16 | 30/25,4 | 3,2 | |
| SXF450 | 450 | 18 | 30/25,4 | 3,2 | |

SXA - LASER

DNA EVO3

Asfalto
Asphalt
Asfalto



GOLD LINE
"HIGH TECHNOLOGY"

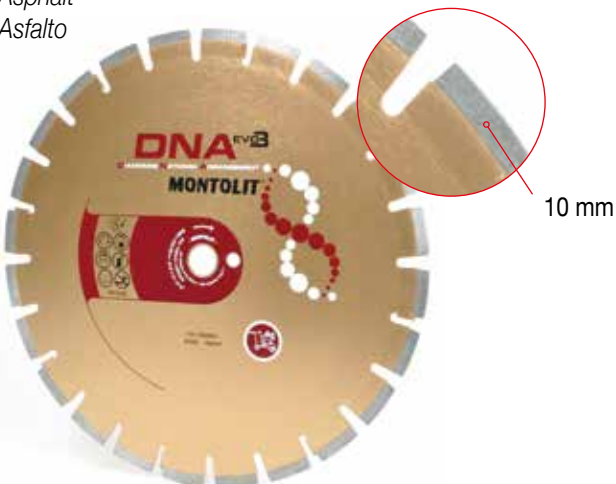

| | |
|------------------------------|--------------------------|
| Velocità - Speed - Velocidad | Durata - Life - Duración |
| ★★★★ | ★★★★☆ |

| Art. | Ø | | Ø | | |
|--------|-----|------|---------|-----|--|
| | mm | inch | mm | mm | |
| SXA400 | 400 | 16 | 30/25,4 | 3,2 | |
| SXA450 | 450 | 18 | 30/25,4 | 3,6 | |
| SXA500 | 500 | 20 | 30/25,4 | 3,6 | |

MONTOLIT®

Calcestruzzo/Calcestruzzo armato/Materiali edili
Concrete/Reinforced concrete/Building industry
Hormigón/Hormigón armado/Construcción



GOLD LINE
"HIGH TECHNOLOGY"

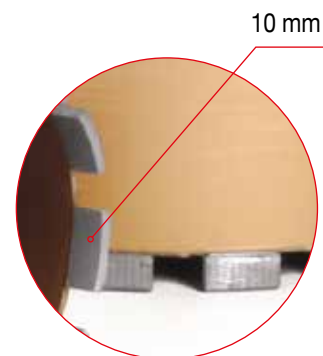

pg.
44

Accessori
Fittings
Accesorios

| Art. | Ø | | n° | mm | n° giri RPM | Potenza consigliata Suggested power Potencia sugerida | |
|-------|-----|--------|----|-----|-------------|---|-------|
| | mm | inch | | | | W min | W max |
| FX 32 | 32 | 1-1/4 | 4 | 450 | 800 ÷ 1.800 | 1.200 | 1.800 |
| FX 36 | 36 | 1-7/16 | 4 | 450 | 700 ÷ 1.700 | 1.200 | 1.800 |
| FX 42 | 42 | 1-5/8 | 5 | 450 | 700 ÷ 1.700 | 1.200 | 1.800 |
| FX 47 | 47 | 1-7/8 | 5 | 450 | 600 ÷ 1.500 | 1.200 | 1.800 |
| FX 52 | 52 | 2-1/16 | 4 | 450 | 500 ÷ 1.300 | 1.200 | 1.800 |
| FX 62 | 62 | 2-7/16 | 5 | 450 | 450 ÷ 1.100 | 1.200 | 1.800 |
| FX 82 | 82 | 3-1/4 | 7 | 450 | 350 ÷ 800 | 1.200 | 2.200 |
| FX 92 | 92 | 3-5/8 | 7 | 450 | 320 ÷ 720 | 1.200 | 2.200 |
| FX102 | 102 | 4 | 8 | 450 | 280 ÷ 650 | 1.200 | 2.200 |
| FX112 | 112 | 4-7/16 | 9 | 450 | 250 ÷ 600 | 1.800 | 2.500 |
| FX122 | 122 | 4-3/4 | 10 | 450 | 230 ÷ 550 | 1.800 | 2.500 |
| FX127 | 127 | 5 | 11 | 450 | 230 ÷ 550 | 1.800 | 2.500 |
| FX132 | 132 | 5-3/16 | 11 | 450 | 230 ÷ 550 | 1.800 | 2.500 |
| FX142 | 142 | 5-5/8 | 11 | 450 | 230 ÷ 550 | 1.800 | 2.500 |
| FX152 | 152 | 6 | 12 | 450 | 200 ÷ 500 | 1.800 | 2.500 |
| FX162 | 162 | 6-3/8 | 12 | 450 | 180 ÷ 450 | 1.800 | 2.500 |
| FX182 | 182 | 7-3/16 | 14 | 450 | 150 ÷ 380 | 2.000 | 3.000 |
| FX202 | 202 | 8 | 15 | 450 | 150 ÷ 380 | 2.000 | 3.300 |
| FX225 | 225 | 8-7/8 | 15 | 450 | 150 ÷ 380 | 2.000 | 3.300 |
| FX250 | 250 | 9-7/8 | 18 | 450 | 150 ÷ 380 | 2.000 | 3.300 |

VELOCITÀ CONSIGLIATA
RECOMMENDED SPEED
VELOCIDAD RECOMENDADA

| | |
|--|-----------|
| Materiale tenero Soft material Material suave | 3-4 m/s |
| Materiale medio Medium material Material mediano | 2-3 m/s |
| Materiale duro Hard material Material duro | 1,5-2 m/s |

FUXLT TURBO LASER

DNA EVO3

Calcestruzzo/Calcestruzzo armato/Laterizio/Mattoni abrasivi/
Autobloccanti
Concrete/Reinforced concrete/Bricks/Abrasive bricks and
self-blocking
Hormigón/Hormigón armado/Ladrillo/Ladrillos abrasivos y
autobloqueantes



GOLD LINE
"HIGH TECHNOLOGY"

Corpo conico - Massima velocità
Reduced conical body - Max speed
Cuerpo cónico máxima velocidad

Saldatura laser utilizzo a secco
Laser welding dry use
Soldadura láser utilización en seco

Attacco 1-1/4" imbocco largo
max asportazione polveri
Thread 1-1/4" large size thread
vacuum dust removal
Conexión 1-1/4" entrada ancha
(máx. Extracción polvos)

DNA SPECIAL TURBO massime prestazioni
SPECIAL TURBO DNA max performance
DNA SPECIAL TURBO máximas prestaciones

10 mm



Corpo spiralato
rimozione polvere agevolata
Spiral body shape
fast dust removal
Cuerpo de espiral extracción polvo
facilitada



pg. 44 Accessori
Fittings
Accesorios

VELOCITÀ CONSIGLIATA
RECOMMENDED SPEED
VELOCIDAD RECOMENDADA

| | |
|--|-----------|
| Materiale tenero Soft material Material suave | 3-4 m/s |
| Materiale medio Medium material Material mediano | 2-3 m/s |
| Materiale duro Hard material Material duro | 1,5-2 m/s |

| Art. | Ø | | n° | mm | n° giri RPM | Potenza consigliata Suggested power Potencia sugerida | |
|----------|-----|----------|----|-----|----------------|---|-------|
| | mm | inch | | | | W min | W max |
| FUXLT 32 | 32 | 1-1/4" | 3 | 300 | 800 ÷ 1.800 | 1.200 | 1.800 |
| FUXLT 42 | 42 | 1-5/8" | 3 | 300 | 700 ÷ 1.700 | 1.200 | 1.800 |
| FUXLT 52 | 52 | 2-1/16" | 3 | 300 | 500 ÷ 1.300 | 1.200 | 1.800 |
| FUXLT 62 | 62 | 2-7/16" | 3 | 300 | 450 ÷ 1.100 | 1.200 | 1.800 |
| FUXLT 68 | 68 | 2-11/16" | 3 | 300 | 400 ÷ 900 | 1.200 | 2.200 |
| FUXLT 82 | 82 | 3-1/4" | 4 | 300 | 350 ÷ 800 | 1.200 | 2.200 |
| FUXLT102 | 102 | 4" | 5 | 300 | 280 ÷ 650 | 1.200 | 2.200 |
| FUXLT112 | 112 | 4-7/16" | 6 | 300 | 250 ÷ 600 | 1.800 | 2.500 |
| FUXLT127 | 127 | 5" | 6 | 300 | 230 ÷ 550 | 1.800 | 2.500 |
| FUXLT162 | 162 | 6-3/8" | 8 | 300 | 180 ÷ 450 | 1.800 | 2.500 |

FUXT LASER

DNA EVO3

Calcestruzzo/Calcestruzzo armato/Laterizio/Mattoni abrasivi/Autobloccanti
Concrete/Reinforced concrete/Bricks/Abrasive bricks and self-blocking
Hormigón/Hormigón armado/Ladrillo/Ladrillos abrasivos y autobloqueantes



GOLD LINE
"HIGH TECHNOLOGY"

Attacco M16
Thread M16
Conexión M16

Asole speciali rimozione polvere agevolata
Top slots fast dust removal
Ranuras especiales extracción polvo facilitada

Corpo conico massima velocità
Reduced conical body max speed
Cuerpo cónico máxima velocidad

DNA SPECIAL TURBO massime prestazioni
SPECIAL TURBO DNA max performance
DNA SPECIAL TURBO máximas prestaciones

10 mm

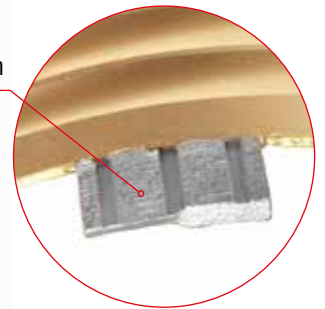

Saldatura laser utilizzo a secco
Laser welding dry use
Soldadura láser utilización en seco

Corpo spiralato rimozione polvere agevolata
Spiral body shape fast dust removal
Cuerpo de espiral extracción polvo facilitada



| Art. | Ø | | n° | mm | n° giri RPM | Potenza consigliata Suggested power Potencia sugerida | |
|---------|-----|---------|-----|----|-------------|---|-------------|
| | mm | inch | | | | W min | W max |
| FUXT 32 | 32 | 1-1/4 | M16 | 3 | 150 | 800 ÷ 1.800 | 1.200 1.800 |
| FUXT 36 | 36 | 1-7/16 | M16 | 3 | 150 | 700 ÷ 1.700 | 1.200 1.800 |
| FUXT 42 | 42 | 1-5/8 | M16 | 3 | 150 | 700 ÷ 1.700 | 1.200 1.800 |
| FUXT 47 | 47 | 1-7/8 | M16 | 3 | 150 | 600 ÷ 1.500 | 1.200 1.800 |
| FUXT 52 | 52 | 2-1/16 | M16 | 3 | 150 | 500 ÷ 1.300 | 1.200 1.800 |
| FUXT 57 | 57 | 2-1/4 | M16 | 3 | 150 | 450 ÷ 1.200 | 1.200 1.800 |
| FUXT 62 | 62 | 2-7/16 | M16 | 3 | 150 | 450 ÷ 1.100 | 1.200 1.800 |
| FUXT 68 | 68 | 2-11/16 | M16 | 4 | 150 | 400 ÷ 900 | 1.200 2.200 |
| FUXT 82 | 82 | 3-1/4 | M16 | 4 | 150 | 350 ÷ 800 | 1.200 2.200 |
| FUXT 92 | 92 | 3-5/8 | M16 | 4 | 150 | 320 ÷ 720 | 1.200 2.200 |
| FUXT102 | 102 | 4 | M16 | 5 | 150 | 280 ÷ 650 | 1.200 2.200 |
| FUXT112 | 112 | 4-7/16 | M16 | 5 | 150 | 250 ÷ 600 | 1.800 2.500 |
| FUXT127 | 127 | 5 | M16 | 6 | 150 | 230 ÷ 550 | 1.800 2.500 |
| FUXT132 | 132 | 5-3/16 | M16 | 7 | 150 | 230 ÷ 550 | 1.800 2.500 |
| FUXT142 | 142 | 5-5/8 | M16 | 7 | 150 | 230 ÷ 550 | 1.800 2.500 |
| FUXT152 | 152 | 6 | M16 | 7 | 150 | 200 ÷ 500 | 1.800 2.500 |
| FUXT162 | 162 | 6-3/8 | M16 | 8 | 150 | 180 ÷ 450 | 1.800 2.500 |
| FUXT182 | 182 | 7-3/16 | M16 | 9 | 150 | 150 ÷ 380 | 2.000 3.000 |
| FUXT202 | 202 | 8 | M16 | 9 | 150 | 150 ÷ 380 | 2.000 3.000 |

pg. 107 → Espositore
Display
Expositor

pg. 44 → Accessori
Fittings
Accesorios

**VELOCITÀ CONSIGLIATA
RECOMMENDED SPEED
VELOCIDAD RECOMENDADA**

| | |
|--|-----------|
| Materiale tenero Soft material Material suave | 3-4 m/s |
| Materiale medio Medium material Material mediano | 2-3 m/s |
| Materiale duro Hard material Material duro | 1,5-2 m/s |

FUTS SPIRAL TURBO

Calcestruzzo/Calcestruzzo armato/Laterizio/Mattoni abrasivi e autobloccanti
 Concrete/Reinforced concrete/Bricks/Abrasive bricks and self-blocking
 Hormigón/Hormigón armado/Ladrillo/Ladrillos abrasivos y autobloqueantes



Attacco M16
 Thread M16
 Conexión M16

Corpo spiralato rimozione
 polvere agevolata
 Spiral body shape fast dust
 removal
 Cuerpo de espiral extracción
 polvo facilitada

12 mm

Asole speciali rimozione
 polvere agevolata
 Top slots fast dust removal
 Ranuras especiales extracción
 polvo facilitada

Saldatura laser utilizzo a secco
 Laser welding dry use
 Soldadura láser utilización en seco



| Art. | Ø | | n° | mm | n° giri RPM | Potenza consigliata Suggested power Potencia sugerida | |
|---------|-----|---------|-----|----|-------------|---|-------------|
| | mm | inch | | | | W min | W max |
| FUTS 32 | 32 | 1-1/4 | M16 | 3 | 150 | 800 ÷ 1.800 | 1.200 1.800 |
| FUTS 36 | 36 | 1-7/16 | M16 | 3 | 150 | 700 ÷ 1.700 | 1.200 1.800 |
| FUTS 42 | 42 | 1-5/8 | M16 | 3 | 150 | 700 ÷ 1.700 | 1.200 1.800 |
| FUTS 47 | 47 | 1-7/8 | M16 | 3 | 150 | 600 ÷ 1.500 | 1.200 1.800 |
| FUTS 52 | 52 | 2-1/16 | M16 | 3 | 150 | 500 ÷ 1.300 | 1.200 1.800 |
| FUTS 57 | 57 | 2-1/4 | M16 | 3 | 150 | 450 ÷ 1.200 | 1.200 1.800 |
| FUTS 62 | 62 | 2-7/16 | M16 | 3 | 150 | 450 ÷ 1.100 | 1.200 1.800 |
| FUTS 68 | 68 | 2-11/16 | M16 | 4 | 150 | 400 ÷ 900 | 1.200 2.200 |
| FUTS 82 | 82 | 3-1/4 | M16 | 4 | 150 | 350 ÷ 800 | 1.200 2.200 |
| FUTS 92 | 92 | 3-5/8 | M16 | 4 | 150 | 320 ÷ 720 | 1.200 2.200 |
| FUTS102 | 102 | 4 | M16 | 5 | 150 | 280 ÷ 650 | 1.200 2.200 |
| FUTS112 | 112 | 4-7/16 | M16 | 5 | 150 | 250 ÷ 600 | 1.800 2.500 |
| FUTS127 | 127 | 5 | M16 | 6 | 150 | 230 ÷ 550 | 1.800 2.500 |
| FUTS132 | 132 | 5-3/16 | M16 | 6 | 150 | 230 ÷ 550 | 1.800 2.500 |
| FUTS152 | 152 | 6 | M16 | 7 | 150 | 200 ÷ 500 | 1.800 2.500 |
| FUTS162 | 162 | 6-3/8 | M16 | 8 | 150 | 180 ÷ 450 | 1.800 2.500 |
| FUTS182 | 182 | 7-3/16 | M16 | 8 | 150 | 150 ÷ 380 | 2.000 3.000 |
| FUTS202 | 202 | 8 | M16 | 9 | 150 | 150 ÷ 380 | 2.000 3.300 |

pg. 44 → Accessori
 Fittings
 Accesorios

VELOCITÀ CONSIGLIATA
 RECOMMENDED SPEED
 VELOCIDAD RECOMENDADA

| | |
|--|-----------|
| Materiale tenero Soft material Material suave | 3-4 m/s |
| Materiale medio Medium material Material mediano | 2-3 m/s |
| Materiale duro Hard material Material duro | 1,5-2 m/s |

CERMONT - CONTINUOUS RIM

Mosaico vetroso e/o in pietra naturale/Ceramica sottile e delicata
Naturalstone and glass mosaic/Slim and soft ceramic
Mosaico vidriato y/o en piedra natural/Cerámica fina y delicada



SILVER LINE
"TOP"



| Velocità - Speed - Velocidad | Durata - Life - Duración | Finitura - Finishing - Acabado |
|------------------------------|--------------------------|--------------------------------|
| ★★★★☆ | ★★★★☆ | ★★★★☆ |

| Art. | | | | | | |
|-------|-----|------|------|-----|----|----|
| | mm | inch | mm* | mm | mm | mm |
| CM100 | 100 | 4 | 22,2 | 1,2 | | |
| CM115 | 115 | 4,5 | 22,2 | 1,2 | | |
| CM125 | 125 | 5 | 22,2 | 1,2 | | |

* 5/8 inch: Riduzione a richiesta • Reduction on request • Reducción a pedido

Massima finitura, velocità ridotta, non forzare
Clean cut, low speed, don't force while cutting
Corte limpio a baja velocidad, no fuerce mientras corta



| IT | GB | ES | |
|--|---|--|-------|
| Mosaico vetroso | Glass mosaic | Mosaico de vidrio | ★★★★★ |
| Mosaico in gres porcellanato | Porcelain stoneware mosaic | Mosaico de gres porcelánico | ★★★★★ |
| Mosaico in pietra naturale | Natural stone mosaic | Mosaico en piedra natural | ★★★★★ |
| Lastre sottili in gres porcellanato | Porcelain stoneware slim slabs | Losas finas de gres porcelánico | ★★★★★ |
| Piastrelle in bicottura, piastrelle delicate | Double fired glazed tiles, delicate tiles | Baldosas de doble cocción, cerámica delicada | ★★★★☆ |

SLIM CUT - ULTRATHIN

Lastre sottili in gres porcellanato
Porcelain stoneware slim slabs
Losas finas de gres porcelánico



SILVER LINE
"TOP"

| Velocità - Speed - Velocidad | Durata - Life - Duración | Finitura - Finishing - Acabado |
|------------------------------|--------------------------|--------------------------------|
| ★★★★☆ | ★★★★☆ | ★★★★★ |

ATTENZIONE! USARE ESCLUSIVAMENTE CON TUTORCUT O MOTO FLASH LINE
ATTENTION! USE ONLY WITH TUTORCUT OR MOTO FLASH LINE.
¡ATENCIÓN! UTILICE SOLO CON TUTORCUT O MOTO FLASH LINE.

| Art. | | | | | | |
|--------------|--|------|------|-----|----|----|
| | mm | inch | mm | mm | mm | mm |
| CSS100 * | 100 | 4 | 22,2 | 1,0 | | |
| CSS150 | 150 | 6 | 30 | 1,3 | | |
| CSS100-T-U * | N° 1 art. CSS100 + N° 1 art. TUTORCUT115-U | | | | | |

* 5/8 inch: Riduzione a richiesta • Reduction on request • Reducción a pedido

Massima finitura, velocità ridotta, non forzare!!
Clean cut, low speed, don't force while cutting
Corte limpio a baja velocidad, no fuerce mientras corta

| IT | GB | ES | |
|-------------------------------------|--------------------------------|---------------------------------|-------|
| Lastre sottili in gres porcellanato | Porcelain stoneware slim slabs | Losas finas de gres porcelánico | ★★★★★ |
| Piastrelle con smalto vetroso | Glass tiles glazed | Baldosas con esmalte vítreo | ★★★★★ |
| Piastrelle in bicottura | Double fired glazed tiles | Baldosas de doble cocción | ★★★★★ |
| Piastrelle in monocottura | Single-fired ceramic tiles | Baldosas de cerámica | ★★★★☆ |

CG - CONTINUOUS RIM

Gres porcellanato/Ceramica dura
Porcelain stoneware/Hard ceramic
Gres porcelánico/Cerámica dura



RED LINE
"PROFESSIONAL"

| Velocità - Speed - Velocidad | Durata - Life - Duración | Finitura - Finishing - Acabado |
|------------------------------|--------------------------|--------------------------------|
| ★★★★ | ★★★★☆ | ★★★★☆ |

| Art. | | | | | | |
|-------|-----|------|------|-----|----|----|
| | mm | inch | mm* | mm | mm | mm |
| CG115 | 115 | 4,5 | 22,2 | 1,4 | | |
| CG125 | 125 | 5 | 22,2 | 1,4 | | |
| CG230 | 230 | 9 | 22,2 | 2,0 | | |

* 5/8 inch: Riduzione a richiesta • Reduction on request • Reducción a pedido

| IT | GB | ES | |
|--|--|---|-------|
| Gres porcellanato, klinker, monocottura | Porcelain stoneware, klinker, single-fired ceramic | Gres porcelánico, klinker, cerámica | ★★★★★ |
| Lastre sottili in gres porcellanato | Porcelain stoneware slim slabs | Losas finas de gres porcelánico | ★★★★★ |
| Gres porcellanato alto spessore | Porcelain stoneware high thickness | Gres porcelánico de alto espesor | ★★★★★ |
| Piastrelle in granito e pietra naturale | Granite tiles and natural stone | Baldosas de granito y piedras naturales | ★★★★☆ |
| Piastrelle delicate, piastrelle in marmo | Delicate tiles, marble tile | Delicadas baldosas, baldosas de mármol | ★★★★☆ |

CSE - CONTINUOUS RIM

Ceramica/Gres porcellanato
Ceramic/Porcelain stoneware
Cerámica/Gres porcelánico



BLU LINE
"UNIVERSAL"

| Velocità - Speed - Velocidad | Durata - Life - Duración | Finitura - Finishing - Acabado |
|------------------------------|--------------------------|--------------------------------|
| ★★★★☆ | ★★★★☆ | ★★★★☆ |

| Art. | | | | | | |
|---------|-----|------|------|-----|----|----|
| | mm | inch | mm* | mm | mm | mm |
| CSE115 | 115 | 4,5 | 22,2 | 1,6 | | |
| CSE230P | 230 | 9 | 22,2 | 2,0 | | |

* 5/8 inch: Riduzione a richiesta • Reduction on request • Reducción a pedido

| IT | GB | ES | |
|--|---|---|-------|
| Gres porcellanato | Porcelain stoneware | Gres porcelánico | ★★★★★ |
| Piastrelle in monocottura, cotto | Single-fired ceramic tiles, terracotta | Baldosas de cerámica, terracota | ★★★★★ |
| Piastrelle in granito e pietre naturali | Granite tiles and natural stone | Baldosas de granito y piedras naturales | ★★★★☆ |
| Piastrelle in bicottura, piastrelle in marmo | Double fired glazed tiles, marble tiles | Baldosas de doble cocción, baldosas de mármol | ★★★★☆ |
| Piastrelle con smalto vetroso | Glass tiles glazed tiles | Baldosas con esmalte vítreo | ★★★★☆ |

TURMONT - CONTINUOUS RIM



TURMONT - CONTINUOUS RIM

Gres porcellanato/Ceramica dura
 Porcelain stoneware/Hard ceramic
 Gres porcelánico/Cerámica dura



RED LINE
 "PROFESSIONAL"

| | | |
|---------------------------------------|-----------------------------------|---|
| Velocità - Speed - Velocidad ★★★★☆ | Durata - Life - Duración ★★★★☆ | Finitura - Finishing - Acabado ★★★★★ |
|---------------------------------------|-----------------------------------|---|

| | | | |
|---------|---------------------|----------|--------|
| Art. | | | |
| TCS85 * | mm 85 inch 3-3/8 | mm* 22,2 | mm 1,0 |

* 5/8 inch: Riduzione a richiesta • Reduction on request • Reducción a pedido

* **XLOCK**: A richiesta • On request • Apedido



Mini disco, ultrasottile
 Mini blade, ultrathin
 Mini disco ultra delgado

| IT | GB | ES | |
|--|------------------------------------|---|-------|
| Gres porcellanato | Porcelain stoneware | Gres porcelánico | ★★★★★ |
| Lastre sottili in gres porcellanato | Porcelain stoneware slim slabs | Losas finas de gres porcelánico | ★★★★☆ |
| Gres porcellanato alto spessore | Porcelain stoneware high thickness | Gres porcelánico de alto espesor | ★★★★☆ |
| Piastrelle in granito e pietra naturale | Granite tiles and natural stone | Baldosas de granito y piedras naturales | ★★★★☆ |
| Piastrelle delicate, piastrelle in marmo | Delicate tiles, marble tile | Delicadas baldosas, baldosas de mármol | ★★★★☆ |

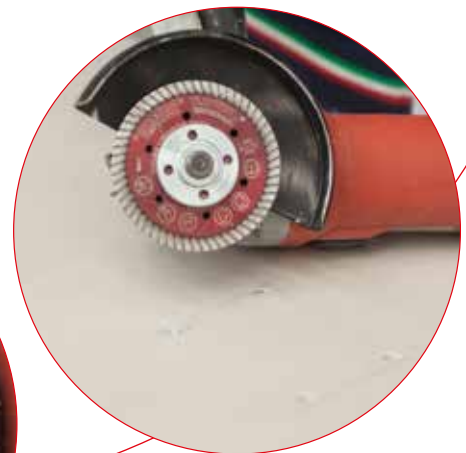

TURMONT - CONTINUOUS RIM

Gres porcellanato/Ceramica dura
 Porcelain stoneware/Hard ceramic
 Gres porcelánico/Cerámica dura



| | | |
|------------------------------|--------------------------|--------------------------------|
| Velocità - Speed - Velocidad | Durata - Life - Duración | Finitura - Finishing - Acabado |
| ★★★★☆ | ★★★★☆ | ★★★★☆ |

| Art. | Ø | | Ø | |
|------------------|------------|----------|----------------|------------|
| | mm | inch | mm* | mm |
| TCS100R | 100 | 4 | 22,2/15,8 | 1,4 |
| TCS115R * | 115 | 4,5 | 22,2 | 1,4 |
| TCS125R * | 125 | 5 | 22,2 | 1,4 |
| TCS150MFL | 150 | 6 | 30/22,2 | 1,4 |
| TCS250R | 250 | 10 | 30/25,4 | 1,65 |

8,5 mm

Special for **MOTO FLASH LINE**

* 5/8 inch: Riduzione a richiesta • Reduction on request • Reducción a pedido

* **XLOCK**: A richiesta • On request • Apedido



Rinforzato
 Reinforced
 Reforzado



Art TCS150MFL

Ultrasottile
 Ultrathin
 Ultra fino



Art TCS100R

| IT | GB | ES | |
|--|------------------------------------|---|-------|
| Gres porcellanato | Porcelain stoneware | Gres porcelánico | ★★★★☆ |
| Lastre sottili in gres porcellanato | Porcelain stoneware slim slabs | Losas finas de gres porcelánico | ★★★★☆ |
| Gres porcellanato alto spessore | Porcelain stoneware high thickness | Gres porcelánico de alto espesor | ★★★★☆ |
| Piastrelle in granito e pietra naturale | Granite tiles and natural stone | Baldosas de granito y piedras naturales | ★★★★☆ |
| Piastrelle delicate, piastrelle in marmo | Delicate tiles, marble tile | Delicadas baldosas, baldosas de mármol | ★★★★☆ |

JOLLY MONT - CONTINUOUS RIM



Gres porcellanato/ Gres porcellanato spessorato/
Ceramica/Granito
Porcelain stoneware/ Porcelain stoneware high thickness/
Ceramic/Granit
Gres porcelánico/ Gres porcelánico de gran espesor/
Cerámicas/Granito



SILVER LINE
"TOP"

| | | |
|------------------------------|--------------------------|--------------------------------|
| Velocità - Speed - Velocidad | Durata - Life - Duración | Finitura - Finishing - Acabado |
| ★★★★☆ | ★★★★★ | ★★★★☆ |

| Art. | | | | |
|-------|-----|------|------|-----|
| | mm | inch | mm* | mm |
| CJ115 | 115 | 4,5 | 22,2 | 1,6 |
| CJ125 | 125 | 5 | 22,2 | 1,6 |

* 5/8 inch: Riduzione a richiesta • Reduction on request • Reducción a pedido

25 mm
FULL DIAMOND



Speciale per Jolly
Special for Jolly
Especial para Jolly



| IT | GB | ES | |
|---|--|---|-------|
| Gres porcellanato, klinker | Porcelain stoneware, klinker | Gres porcelánico, klinker | ★★★★★ |
| Gres porcellanato alto spessore | Porcelain stoneware high thickness | Gres porcelánico de alto espesor | ★★★★★ |
| Piastrelle in monocottura, cotto | Single-fired ceramic tiles, terracotta | Cerámica, terracota | ★★★★★ |
| Piastrelle in granito e pietra naturale | Granite tiles and natural stone | Baldosas de granito y piedras naturales | ★★★★★ |
| Lastre sottili in gres porcellanato | Porcelain stoneware slim slabs | Losas finas de gres porcelánico | ★★★★☆ |



CERMONT - CONTINUOUS RIM

Informazioni rapide:

- Progettato specificamente per il taglio a umido di ogni piastrella di vetro e mosaico di vetro.
- La lama per il taglio del vetro più veloce e pulita del settore
- Riduce drasticamente gli scarti
- Prestazioni eccellenti durante il taglio di angoli a 45° o acuti.
- La finitura di alta qualità fornisce tagli simili a quelli di fabbrica.
- Maggiore durata della lama rispetto alle comuni lame per vetro.
- Risparmia tempo ottenendo risultati perfetti!

Quick facts:

- Designed specifically for wet cutting every glass tile and glass mosaic.
- The fastest and cleanest glass cutting blade in the industry
- Drastically reduces the waste
- Top performance while cutting 45° or sharp corners.
- High quality finish provides factory like cuts.
- Longer blade life compared to common glass blades.
- Save your time obtaining perfect results!

Datos rápidos:

- Diseñado específicamente para el corte en húmedo de todas las baldosas de vidrio y vidrio mosaico.
- La cuchilla de corte de vidrio más rápida y limpia de la industria
- Reduce drásticamente los residuos
- Máximo rendimiento al cortar esquinas de 45° o afiladas.
- El acabado de alta calidad proporciona cortes similares a los de fábrica.
- Mayor vida útil de la hoja en comparación con las cuchillas de vidrio comunes.
- ¡Ahorre tiempo obteniendo resultados perfectos!



CERMONT - CONTINUOUS RIM

Piastrelle in vetro
Glass tiles
Baldosas de vidrio



SILVER LINE
"TOP"

| Velocità - Speed - Velocidad | Durata - Life - Duración | Finitura - Finishing - Acabado |
|------------------------------|--------------------------|--------------------------------|
| ☆☆☆☆ | ☆☆☆☆ | ☆☆☆☆ |

| Art. | | | | | | |
|--------|-----|------|---------|-----|--|--|
| | mm | inch | mm* | mm | | |
| CPV100 | 100 | 4 | 22,2 | 1,4 | | |
| CPV180 | 180 | 7 | 30/25,4 | 1,6 | | |
| CPV200 | 200 | 8 | 30/25,4 | 1,6 | | |
| CPV250 | 250 | 10 | 30/25,4 | 1,9 | | |
| CPV300 | 300 | 12 | 30/25,4 | 2,1 | | |

* 5/8 inch: Riduzione a richiesta • Reduction on request • Reducción a pedido



Massima finitura, velocità ridotta, non forzare
Clean cut, low speed, don't force while cutting
Corte limpio a baja velocidad, no fuerce mientras corta

| IT | GB | ES | |
|----------------------------|----------------------|---------------------------|-------|
| Piastrelle in vetro | Glass tiles | Baldosas de vidrio | ☆☆☆☆ |
| Mosaico vetroso | Glass mosaic | Mosaico de vidrio | ☆☆☆☆ |
| Mosaico in pietra naturale | Natural stone mosaic | Mosaico en piedra natural | ☆☆☆☆☆ |

CERMONT - CONTINUOUS RIM

Ceramica/Gres porcellanato/Marmo/Granito
 Ceramic/Porcelain stoneware/Marble/Granite
 Cerámica/Gres porcelánico/Mármol/Granito

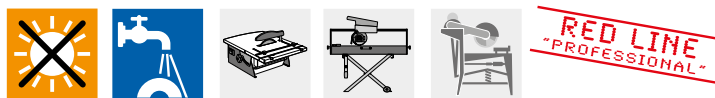

| | | |
|------------------------------|--------------------------|--------------------------------|
| Velocità - Speed - Velocidad | Durata - Life - Duración | Finitura - Finishing - Acabado |
| ★★★★☆ | ★★★☆☆ | ★★★★☆ |



10mm

Massima velocità
 Max speed
 Máxima velocidad

| Art. | | | | | | |
|--------|-----|------|-----------|------|--|--|
| | mm | inch | mm | mm | | |
| CPH180 | 180 | 7 | 25,4/22,2 | 1,6 | | |
| CPH200 | 200 | 8 | 30/25,4 | 1,6 | | |
| CPH230 | 230 | 9 | 30/25,4 | 1,6 | | |
| CPH250 | 250 | 10 | 30/25,4 | 1,65 | | |
| CPH300 | 300 | 12 | 30/25,4 | 2,0 | | |
| CPH350 | 350 | 14 | 30/25,4 | 2,2 | | |

| IT | GB | ES | |
|---|--|---|-------|
| Gres porcellanato, klinker | Porcelain stoneware, klinker | Gres porcelánico, klinker | ★★★★☆ |
| Piastrelle in monocottura, cotto | Single-fired ceramic tiles, terracotta | Baldosas de cerámica, terracota | ★★★★☆ |
| Piastrelle in granito e pietra naturale | Granite tiles and natural stone | Baldosas de granito y piedras naturales | ★★★★☆ |
| Piastrelle in marmo | Marble tiles | Baldosas de mármol | ★★★★☆ |
| Piastrelle in bicottura | Double fired glazed tiles | Baldosas de doble cocción | ★★★★☆ |

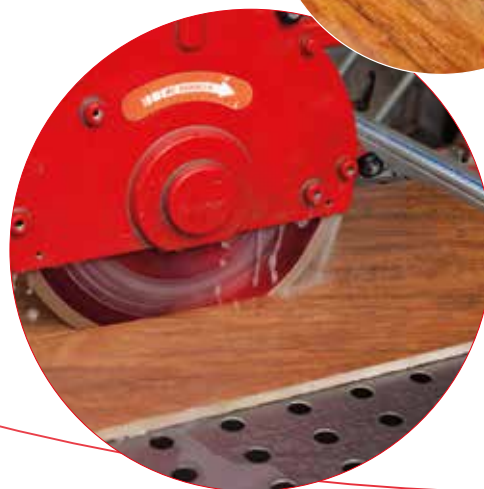

CERMONT - CONTINUOUS RIM

Gres Porcellanato/Ceramica delicata/Vetro/Marmo/Granito
 Porcelain stoneware/Soft ceramic/Glass/Marble/Granite
 Gres porcelánico/Cerámica esmaltada y delicada/Vidrio/
 Mármol/Granito



10mm

| | | |
|------------------------------|--------------------------|--------------------------------|
| Velocità - Speed - Velocidad | Durata - Life - Duración | Finitura - Finishing - Acabado |
| ★★★★ | ★★★☆☆ | ★★★★★ |

| Art. | Ø | | Ø | |
|--------|-----|------|-----------|-----|
| | mm | inch | mm | mm |
| CPF180 | 180 | 7 | 25,4/22,2 | 2,0 |
| CPF200 | 200 | 8 | 30/25,4 | 2,0 |
| CPF230 | 230 | 9 | 30/25,4 | 2,0 |
| CPF250 | 250 | 10 | 30/25,4 | 2,0 |
| CPF300 | 300 | 12 | 30/25,4 | 2,2 |
| CPF350 | 350 | 14 | 30/25,4 | 2,2 |

| IT | GB | ES | |
|---|--|---|-------|
| Piastrelle in vetro | Glass tiles | Baldosas de vidrio | ★★★★★ |
| Gres porcellanato | Porcelain stoneware | Gres porcelánico | ★★★★★ |
| Piastrelle in monocottura e bicottura | Single-fired and double fired glazed tiles | Baldosas de cerámica y de doble cocción | ★★★★★ |
| Piastrelle in marmo | Marble tiles | Baldosas de mármol | ★★★★☆ |
| Piastrelle in granito e pietre naturali | Granite tiles and natural stone | Baldosas de granito y piedras naturales | ★★★☆☆ |

Massima finitura, velocità ridotta, non forzare
 Clean cut, low speed, don't force while cutting
 Corte limpio a baja velocidad, no fuerce mientras corta

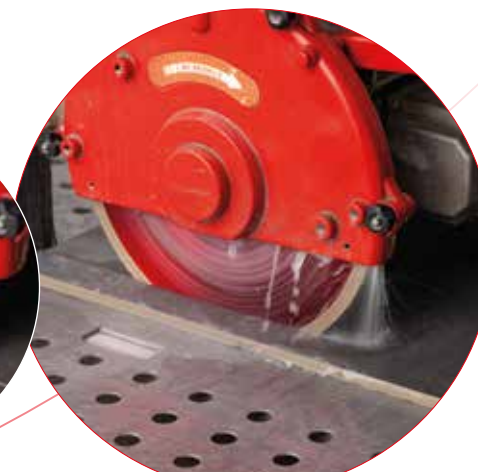

TURMONT - TURBO

Edilizia
Building industry
Construcción



BLU LINE
"UNIVERSAL"

| | | |
|------------------------------|--------------------------|--------------------------------|
| Velocità - Speed - Velocidad | Durata - Life - Duración | Finitura - Finishing - Acabado |
| ★★★★☆ | ★★★★☆ | ★★★★☆ |

| Art. | Ø | | Ø | | |
|---------|-----|------|------|-----|--|
| | mm | inch | mm* | mm | |
| TEH115 | 115 | 4,5 | 22,2 | 2,2 | |
| TEH125 | 125 | 5 | 22,2 | 2,2 | |
| TEH230P | 230 | 9 | 22,2 | 2,4 | |

* 5/8 inch: Riduzione a richiesta • Reduction on request • Reducción a pedido

| IT | GB | ES | |
|---|---|---|-------|
| Tegole, laterizio, mattoni, calcestruzzo | Roof tiles, brick, concrete | Tejas, ladrillos, hormigón | ★★★★★ |
| Autobloccanti, arenaria, poroton® | Self-locking bricks, sandstone, poroton® | Autobloqueantes, arenisca, poroton® | ★★★★☆ |
| Calcestruzzo leggermente armato, calcestruzzo abrasivo. | Lightly reinforced concrete, abrasive concrete. | Hormigón ligeramente armado, hormigón abrasivo. | ★★★★☆ |
| Granito, pietra, porfido | Granite, stone, porphyry | Granito, piedra, pórfido | ★★★★☆ |
| Marmo, ceramica, gres porcellanato. | Marble, ceramic, porcelain stoneware. | Mármol, cerámica, gres porcelánico. | ★★★☆☆ |

TURMONT - TURBO PRO

Calcestruzzo/Granito/Gres porcellanato spessorato
Concrete/Granite/Porcelain stoneware high thickness
Hormigón/Granito/Gres porcelánico de gran espesor



RED LINE
"PROFESSIONAL"

| | | |
|------------------------------|--------------------------|--------------------------------|
| Velocità - Speed - Velocidad | Durata - Life - Duración | Finitura - Finishing - Acabado |
| ★★★★★ | ★★★★★ | ★★★★☆ |

| Art. | Ø | | Ø | | |
|----------|-----|------|---------|-----|--|
| | mm | inch | mm* | mm | |
| TBH115 * | 115 | 4,5 | 22,2 | 2,4 | |
| TBH125 * | 125 | 5 | 22,2 | 2,4 | |
| TBH150 | 150 | 6 | 30/22,2 | 2,4 | |
| TBH180 | 180 | 7 | 22,2 | 2,4 | |
| TBH200 | 200 | 8 | 30/25,4 | 2,4 | |
| TBH230P | 230 | 9 | 22,2 | 2,4 | |
| TBH250 | 250 | 10 | 30/25,4 | 2,8 | |
| TBH300 | 300 | 12 | 30/25,4 | 2,8 | |
| TBH350 | 350 | 14 | 30/25,4 | 3,3 | |

| IT | GB | ES | |
|---|---|---|-------|
| Tegole, laterizio, mattoni, calcestruzzo | Roof tiles, brick, concrete | Tejas, ladrillos, hormigón | ★★★★★ |
| Granito, pietra, porfido, refrattario | Granite, stone, porphyry, refractory | Granito, piedra, pórfido, refrattario | ★★★★★ |
| Calcestruzzo leggermente armato, calcestruzzo abrasivo. | Lightly reinforced concrete, abrasive concrete. | Hormigón ligeramente armado, hormigón abrasivo. | ★★★★☆ |
| Autobloccanti, arenaria, poroton® | Self-locking bricks, sandstone, poroton® | Autobloqueantes, arenisca, poroton® | ★★★★☆ |
| Marmo, ceramica, gres porcellanato. | Marble, ceramic, porcelain stoneware. | Mármol, cerámica, gres porcelánico. | ★★★☆☆ |



Speciale per gres porcellanato alto spessore
Special for porcelain stoneware high thickness
Especial para gres porcelánico de alto espesor.

* 5/8 inch: Riduzione a richiesta • Reduction on request • Reducción a pedido

* XLOCK: A richiesta • On request • A pedido

LASERMONT - LASER

Edilizia
Building industry
Construcción



| Velocità - Speed - Velocidad | Durata - Life - Duración | Finitura - Finishing - Acabado |
|------------------------------|--------------------------|--------------------------------|
| ★★★★☆ | ★★★★☆ | ★★★★☆ |

| Art. | Ø | | Ø | | |
|----------|-----|------|------------|-----|--|
| | mm | inch | mm* | mm | |
| LEH115 | 115 | 4,5 | 22,2 | 2,2 | |
| LEH125 | 125 | 5 | 22,2 | 2,2 | |
| LEH230P | 230 | 9 | 22,2 | 2,4 | |
| LEH30018 | 300 | 12 | 30/25,4 | 2,8 | |
| LEH35021 | 350 | 14 | 30/25,4 | 3,2 | |
| LEH40024 | 400 | 16 | 30/25,4 | 3,4 | |
| LEH45026 | 450 | 18 | 30/25,4 | 3,6 | |
| LEH50029 | 500 | 20 | 30/25,4 | 3,6 | |
| LEH55032 | 550 | 22 | 30/25,4 | 4,0 | |
| LEH60035 | 600 | 24 | 60/50/25,4 | 4,0 | |
| LEH65037 | 650 | 26 | 60/50/25,4 | 4,0 | |
| LEH72040 | 720 | 29 | 60/50/25,4 | 4,0 | |
| LEH75042 | 750 | 30 | 60/50/25,4 | 4,0 | |

* 5/8 inch: Riduzione a richiesta • Reduction on request • Reducción a pedido

LASERMONT - LASER PRO

Calcestruzzo/Granito/Porfido/Pietre dure
Concrete/Granite/Porphyry/Hard stone
Hormigón/Granito/Pórfido/Piedras duras



| Velocità - Speed - Velocidad | Durata - Life - Duración | Finitura - Finishing - Acabado |
|------------------------------|--------------------------|--------------------------------|
| ★★★★★ | ★★★★★ | ★★★★☆ |

| Art. | Ø | | Ø | | |
|----------|-----|--------|---------|-----|--|
| | mm | inch | mm* | mm | |
| LBH115 | 115 | 4,5 | 22,2 | 2,0 | |
| LBH125 | 125 | 5 | 22,2 | 2,2 | |
| LBH150 * | 150 | 6 | 22,2 | 2,4 | |
| LBH160 * | 160 | 6-5/16 | 22,2 | 2,4 | |
| LBH180 * | 180 | 7 | 22,2 | 2,4 | |
| LBH190 | 190 | 7,5 | 22,2 | 2,4 | |
| LBH200 | 200 | 8 | 30/25,4 | 2,4 | |
| LBH230P | 230 | 9 | 22,2 | 2,4 | |
| LBH250 | 250 | 10 | 30/25,4 | 2,4 | |
| LBH30021 | 300 | 12 | 30/25,4 | 2,8 | |
| LBH35025 | 350 | 14 | 30/25,4 | 3,2 | |
| LBH40028 | 400 | 16 | 30/25,4 | 3,2 | |
| LBH45032 | 450 | 18 | 30/25,4 | 3,4 | |

* 5/8 inch: A richiesta • Reduction on request • Reducción a pedido

* A richiesta • On request • A pedido

LASERMONT- LASER

NEW 2025

Calcestruzzo fortemente armato/Granito/Porfido/Pietre dure/Ferro
Reinforced concrete/Granite/Porphyry/Hard stone/Iron
Hormigón fuertemente armado/Granito/Pórfido/Piedras duras/Hierro



SILVER LINE
"TOP"

10mm

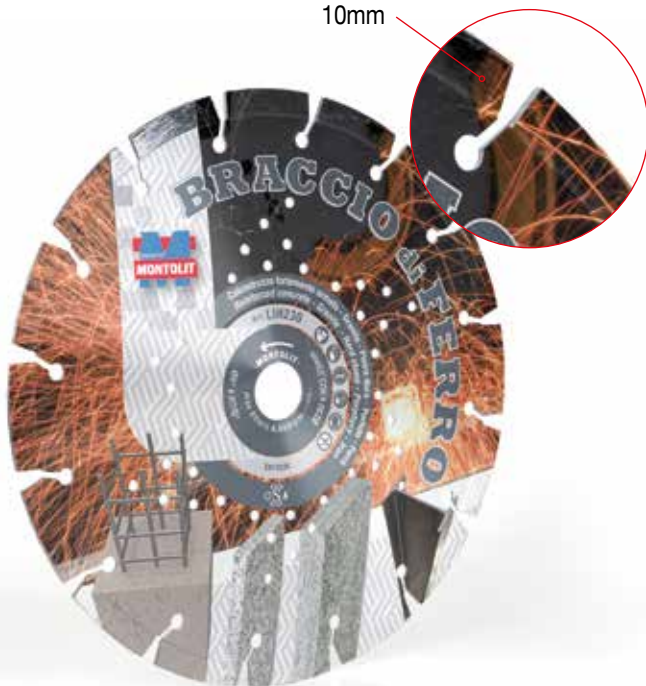

| Velocità - Speed - Velocidad | Durata - Life - Duración | Finitura - Finishing - Acabado |
|------------------------------|--------------------------|--------------------------------|
| ★★★★★ | ★★★★★ | ★★★☆☆ |

| Art. | Ø | | Ø | |
|--------|-----|------|------|-----|
| | mm | inch | mm* | mm |
| LIH230 | 230 | 9 | 22,2 | 2,4 |

* 5/8 inch: Riduzione a richiesta • Reduction on request • Reducción a pedido

| IT | GB | ES | |
|--|--|--|-------|
| Calcestruzzo armato, calcestruzzo compatto | Reinforced concrete, compact concrete | Hormigón armado, hormigón compacto | ★★★★★ |
| Calcestruzzo molto armato, ferro d'armatura | Much reinforced concrete, reinforcing iron | Hormigón fuertemente armado, hierro de refuerzo | ★★★★★ |
| Autobloccanti, arenaria, poroton®, refrattario | Self-locking bricks, sandstone, poroton®, refractory | Autobloqueantes, arenisca, poroton®, refractario | ★★★★★ |
| Granito, pietra, porfido | Granite, stone, porphyry | Granito, piedra, pórfido | ★★★★★ |
| Tegole, laterizio, mattoni | Roof tiles, brick | Tejas, ladrillos | ★★★★☆ |

SECTORMONT - SEGMENTS

Refrattario/Materiali abrasivi/Granito/Porfido
Refractory/Abrasive materials/Granite/Porphyry
Material refractario/Materiales abrasivos/Granito/Pórfido



SILVER LINE
"TOP"

10mm



| Velocità - Speed - Velocidad | Durata - Life - Duración | Finitura - Finishing - Acabado |
|------------------------------|--------------------------|--------------------------------|
| ★★★★☆ | ★★★★★ | ★★★★☆ |

| Art. | Ø | | Ø | |
|-----------|-----|------|---------|-----|
| | mm | inch | mm | mm |
| SR30021 | 300 | 12 | 30/25,4 | 3,0 |
| SR35025 | 350 | 14 | 30/25,4 | 3,2 |
| SR40028 | 400 | 16 | 30/25,4 | 3,5 |
| SR45032 | 450 | 18 | 30/25,4 | 4,0 |
| SR50030 | 500 | 20 | 30/25,4 | 4,5 |
| SR55032 * | 550 | 22 | 30/25,4 | 5,0 |
| SR60036 | 600 | 24 | 30/25,4 | 5,0 |
| SR65038 * | 650 | 26 | 30/25,4 | 5,0 |

* A richiesta • On request • A pedido

| IT | GB | ES | |
|-------------------------------------|--|---|-------|
| Tegole in cotto, laterizio, mattoni | Terracotta roof tiles, bricks | Tejas de terracota, ladrillos | ★★★★★ |
| Granito, pietra naturale | Granite, natural stone | Granito, piedra natural | ★★★★★ |
| Autobloccanti, arenaria, poroton® | Self-locking bricks, sandstone, poroton® | Autobloqueantes, arenisca, poroton® | ★★★★★ |
| Tegole in cemento, mattoni abrasivi | Concrete roof tiles, abrasive bricks | Tejas de hormigón, ladrillos abrasivos. | ★★★★☆ |
| Refrattario | Refractory | Refractario | ★★★★☆ |

DRAGSTER - MONDRILLO

Gres/Marmo/Granito/Calcestruzzo/Ghisa/Metallo/Fibra di vetro/Plastica
 Gres/Marble/Granite/Concrete/Cast iron/Metal plate/Fiberglass/Plastic
 Gres/Mármol/Granito/Hormigón/Hierro fundido/Metal/Fibra de vidrio/
 Plástico



SILVER LINE
"TOP"



| | | |
|------------------------------|--------------------------|--------------------------------|
| Velocità - Speed - Velocidad | Durata - Life - Duración | Finitura - Finishing - Acabado |
| ★★★★★ | ★★★☆☆ | ★★★★★ |

| Art. | Ø | | Ø |
|--------|-----|------|---------|
| | mm | inch | mm* |
| SSD115 | 115 | 4,5 | 22,2 |
| SSD125 | 125 | 5 | 22,2 |
| SSD230 | 230 | 9 | 22,2 |
| SSD300 | 300 | 12 | 30/25,4 |
| SSD350 | 350 | 14 | 30/25,4 |

* 5/8 inch: Riduzione a richiesta • Reduction on request • Reducción a pedido



| IT | GB | ES | |
|------------------------------------|--------------------------------|--|-------|
| Granito, marmo, pietra naturale | Granite, marble, natural stone | Granito, mármol, piedra natural | ★★★★★ |
| Calcestruzzo, materiali edili. | Concrete, building materials | Hormigón, materiales de construcción | ★★★★★ |
| Barre in acciaio, tubi in ghisa. | Steel bars, cast iron pipes | Barras de acero, tubos de hierro fundido | ★★★★☆ |
| Plastica, PVC, vetroresina, legno. | Plastic, PVC, fiberglass, wood | Plástico, PVC, fibra de vidrio, madera | ★★★★☆ |
| Gres porcellanato, ceramica. | Porcelain stoneware, ceramic | Gres porcelánico, cerámica | ★★★★☆ |

ELECTROPLATED

Marmo/Fibre di vetro/Vetroresina
 Marble/Fiberglass
 Mármol/Fibras de vidrio



SILVER LINE
"TOP"

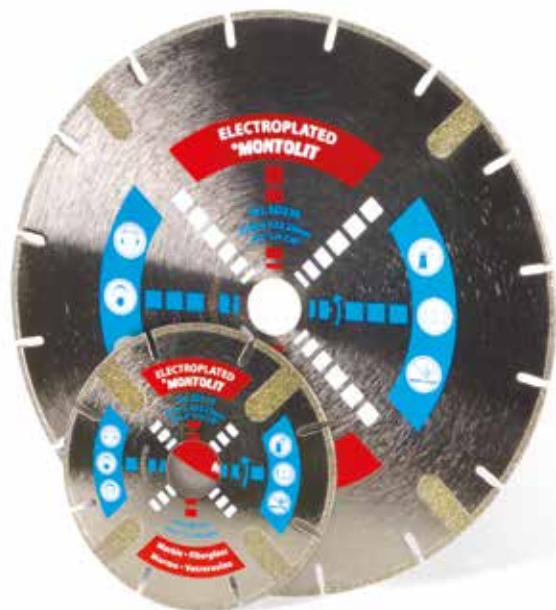

| | | |
|------------------------------|--------------------------|--------------------------------|
| Velocità - Speed - Velocidad | Durata - Life - Duración | Finitura - Finishing - Acabado |
| ★★★★★ | ★★★☆☆ | ★★★★★ |

| Art. | Ø | | Ø |
|--------|-----|------|---------|
| | mm | inch | mm* |
| ED115 | 115 | 4,5 | 22,2 |
| ED125 | 125 | 5 | 22,2 |
| ED180 | 180 | 7 | 22,2 |
| ED200 | 200 | 8 | 22,2 |
| ED230P | 230 | 9 | 22,2 |
| ED250 | 250 | 10 | 30/25,4 |
| ED300 | 300 | 12 | 30/25,4 |
| ED350 | 350 | 14 | 30/25,4 |

* 5/8 inch: Riduzione a richiesta • Reduction on request • Reducción a pedido

| | | | |
|------------------------------|--------------------------|--------------------------|-------|
| Marmo bianco e colorato. | White and colored marble | Mármol blanco y de color | ★★★★★ |
| Vetroresina, fibre di vetro. | Fiberglass | Fibra de vidrio | ★★★★☆ |
| Plastica, PVC. | Plastic, PVC | Plástico, PVC | ★★★★☆ |

CERMONT - CONTINUOUS RIM

Gres porcellanato/Ceramica
Porcelain stoneware/Ceramic
Gres porcelánico/Cerámica



GREEN LINE
"BASIC"

| Velocità - Speed - Velocidad | Durata - Life - Duración | Finitura - Finishing - Acabado |
|------------------------------|--------------------------|--------------------------------|
| ★★★★☆ | ★★★☆☆ | ★★★★☆ |

| Art. | | | | | | |
|-------|-----|------|-----------|-----|----|----|
| | mm | inch | mm* | mm | mm | mm |
| CZ100 | 100 | 4 | 22,2/15,8 | 1,4 | | |
| CZ115 | 115 | 4,5 | 22,2 | 1,4 | | |
| CZ125 | 125 | 5 | 22,2 | 1,4 | | |
| CZ180 | 180 | 7 | 22,2 | 1,6 | | |

* 5/8 inch: Riduzione a richiesta • Reduction on request • Reducción a pedido

TURMONT - CONTINUOUS RIM

Ceramica/Gres porcellanato
Ceramic/Porcelain stoneware
Cerámica/Gres porcelánico



GREEN LINE
"BASIC"

| Velocità - Speed - Velocidad | Durata - Life - Duración | Finitura - Finishing - Acabado |
|------------------------------|--------------------------|--------------------------------|
| ★★★★☆ | ★★★☆☆ | ★★★★☆ |

| Art. | | | | | | |
|---------|-----|------|-----------|-----|----|----|
| | mm | inch | mm* | mm | mm | mm |
| TCS100E | 100 | 4 | 22,2/15,8 | 1,4 | | |
| TCS115E | 115 | 4,5 | 22,2 | 1,4 | | |
| TCS125E | 125 | 5 | 22,2 | 1,4 | | |

* 5/8 inch: Riduzione a richiesta • Reduction on request • Reducción a pedido

TURMONT - TURBO

Edilizia
Building industry
Construcción



GREEN LINE
"BASIC"

| Velocità - Speed - Velocidad | Durata - Life - Duración | Finitura - Finishing - Acabado |
|------------------------------|--------------------------|--------------------------------|
| ★★★★☆ | ★★★☆☆ | ★★★★☆ |

| Art. | | | | | | |
|--------|-----|------|------|-----|----|----|
| | mm | inch | mm* | mm | mm | mm |
| TZ115 | 115 | 4,5 | 22,2 | 2,0 | | |
| TZ230P | 230 | 9 | 22,2 | 2,6 | | |

* 5/8 inch: Riduzione a richiesta • Reduction on request • Reducción a pedido

Foratura
Drilling
Perforación



KILLER GRES - SINTERED DRY DRILLING

Gres porcellanato/Ceramica/Monocottura/Granito
 Porcelain stoneware/Hard ceramic/Granite/Marble
 Gres porcelánico/Cerámica dura/Granito/Mármol

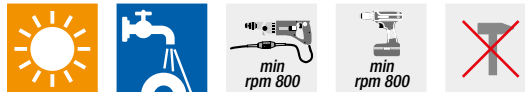

| | | |
|------------------------------|--------------------------|--------------------------------|
| Velocità - Speed - Velocidad | Durata - Life - Duración | Finitura - Finishing - Acabado |
| ★★★★☆ | ★★★★★ | ★★★★☆ |



Lunga durata
 Long Life
 Larga duración

| Art. | mm | inch | mm | max mm |
|-------|----|------|----|--------|
| FTJ05 | 5 | 3/16 | 10 | 30 |
| FTJ06 | 6 | 1/4 | 10 | 30 |
| FTJ08 | 8 | 5/16 | 10 | 30 |
| FTJ10 | 10 | 3/8 | 10 | 30 |
| FTJ12 | 12 | 1/2 | 10 | 30 |

FTJVA-N Box + FTJ 05/06/08/10/12

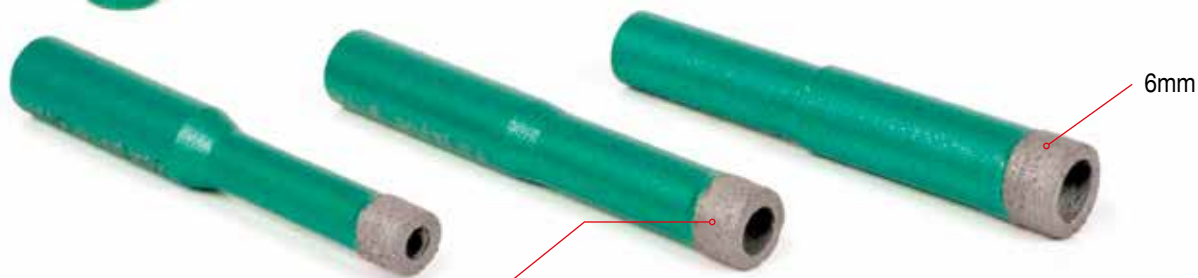

6mm

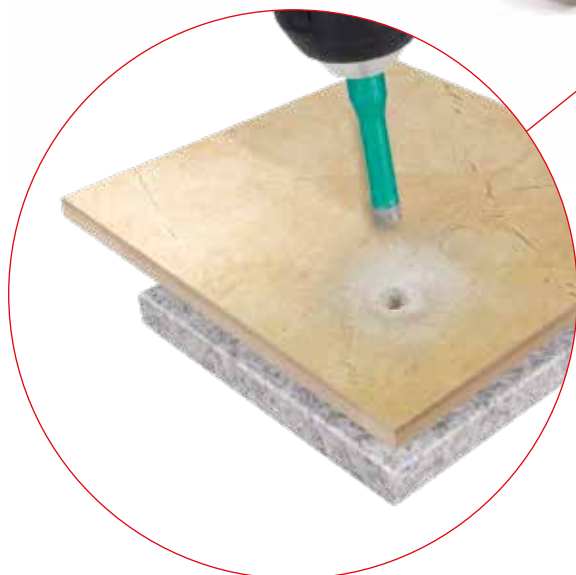

| IT | GB | ES | |
|------------------------------------|-----------------------------|-------------------------------------|-------|
| Gres porcellanato | Porcelain stoneware | Gres porcelánico | ★★★★★ |
| Piastrelle di monocottura, granito | Single-fired tiles, granite | Baldosas de cerámica, granito | ★★★★★ |
| Granito, pietre naturali | Granite, natural stones | Granito, piedras naturales | ★★★★☆ |
| Piastrelle di bicottura e vetrose | Double fired glazed tiles | Baldosas de doble cocción y vítreas | ★★★★☆ |
| Marmo e piastrelle in marmo | Marble and marble tiles | Mármol y baldosas de mármol | ★★★★☆ |



Art. FTJVA-N



pg. 94 → Liquido refrigerante
 → Cooling fluid
 → Líquido refrigerante

MONDRILLO - DRY DRILLING

Gres porcellanato/Ceramica/Monocottura/Granito/Marmo/Vetro
 Porcelain stoneware/Ceramic/Single fired tile/Granite/Marble/Glass
 Gres porcelánico/Cerámica/Granito/Mármol/Vidrio



| | | |
|------------------------------|--------------------------|--------------------------------|
| Velocità - Speed - Velocidad | Durata - Life - Duración | Finitura - Finishing - Acabado |
| ★★★★ | ★★☆☆ | ★★★★ |



4th generation gold diamond technology

+ Velocità + Durata
 + Speed + Life
 + Velocidad + Vida

| Art. | Ø | | max mm | |
|-------|----|------|--------|--------|
| | mm | inch | mm | max mm |
| FAJ04 | 4 | 5/32 | 10 | 40 |
| FAJ05 | 5 | 3/16 | 10 | 40 |
| FAJ06 | 6 | 1/4 | 10 | 40 |
| FAJ08 | 8 | 5/16 | 10 | 40 |
| FAJ10 | 10 | 3/8 | 10 | 40 |
| FAJ12 | 12 | 1/2 | 10 | 40 |

| | | |
|---------|--------------------------|--|
| FAJVA-N | Box + FAJ 05/06/08/10/12 | |
| FAJ6VA | Box + 5 art.FAJ06 | |
| FAJ8VA | Box + 5 art.FAJ08 | |

Gold spiral - new technology



| IT | GB | ES | |
|--|----------------------------------|---|-------|
| Gres porcellanato | Porcelain stoneware | Gres porcelánico | ★★★★★ |
| Piastrelle in monocottura, granito | Single-fired tiles, granite | Baldosas de cerámica, granito | ★★★★★ |
| Marmo e piastrelle in marmo | Marble and marble tiles | Mármol y baldosas de mármol | ★★★★★ |
| Piastrelle in bicottura e vetrose, vetro | Double fired glazed tiles, glass | Baldosas de doble cocción y vítreas, vidrio | ★★★★☆ |
| Piastrelle in granito e pietre naturali | Granite and natural stone tiles | Baldosas de granito y piedras naturales | ★★★★☆ |



Art. FAJVA-N



pg. 107 → Espositore
 Display
 Expositor

pg. 94 → Liquido refrigerante
 Cooling fluid
 Líquido refrigerante



MONDRILLO - DRY DRILLING



Piastrelle in ceramica e pietra naturale
 Ceramic tiles and natural stone
 Baldosas de cerámica y piedra natural



| | | |
|------------------------------|--------------------------|--------------------------------|
| Velocità - Speed - Velocidad | Durata - Life - Duración | Finitura - Finishing - Acabado |
| ★★★★★ | ★★★☆☆ | ★★★★☆ |



12mm



Art.

| Art. | Ø | | max mm |
|---------|-----|---------|----------|
| | mm | inch | |
| FSBH 06 | 6 | 1/4 | M14 * 35 |
| FSBH 08 | 8 | 5/16 | M14 * 35 |
| FSBH 10 | 10 | 3/8 | M14 * 35 |
| FSBH 12 | 12 | 1/2 | M14 * 35 |
| FSBH 14 | 14 | 9/16 | M14 * 35 |
| FSBH 16 | 16 | 5/8 | M14 * 35 |
| FSBH 18 | 18 | 11/16 | M14 * 35 |
| FSBH 20 | 20 | 3/4 | M14 * 35 |
| FSBH 25 | 25 | 1 | M14 * 35 |
| FSBH 27 | 27 | 1-1/16 | M14 * 35 |
| FSBH 30 | 30 | 1-3/16 | M14 * 35 |
| FSBH 35 | 35 | 1-3/8 | M14 * 35 |
| FSBH 40 | 40 | 1-1/2 | M14 * 35 |
| FSBH 45 | 45 | 1-3/4 | M14 * 35 |
| FSBH 50 | 50 | 2 | M14 * 35 |
| FSBH 55 | 55 | 2-3/16 | M14 * 35 |
| FSBH 60 | 60 | 2-3/8 | M14 * 35 |
| FSBH 65 | 65 | 2-1/2 | M14 * 35 |
| FSBH 68 | 68 | 2-11/16 | M14 * 35 |
| FSBH 70 | 70 | 2-3/4 | M14 * 35 |
| FSBH 75 | 75 | 3 | M14 * 35 |
| FSBH 90 | 90 | 3-9/16 | M14 * 35 |
| FSBH100 | 100 | 4 | M14 * 35 |
| FSBH120 | 120 | 4-3/4 | M14 * 35 |



Art. FSBHKIT-IT

FSBHKIT-IT | Box + FSB08 + FSB20 + FSB27 + FSB35 + FSB50

* 5/8 inch: Riduzione a richiesta • Reduction on request • Reducción a pedido

| IT | GB | ES | |
|---|---------------------------------|---|-------|
| Gres porcellanato | Porcelain stoneware | Gres porcelánico | ★★★★★ |
| Piastrelle in granito e pietre naturali | Granite and natural stone tiles | Baldosas de granito y piedras naturales | ★★★★★ |
| Piastrelle in monocottura, granito | Single-fired tiles, granite | Baldosas de cerámica, granito | ★★★★★ |
| Marmo e piastrelle in marmo | Marble and marble tiles | Mármol y baldosas de mármol | ★★★★★ |
| Piastrelle in bicottura e vetrose | Double fired glazed tiles | Baldosas de doble cocción | ★★★★☆ |



pg. 94
 → Liquido refrigerante
 → Cooling fluid
 → Liquido refrigerante



MONDRILLO TITANIUM GOLD - DRY DRILLING



Gres Porcellanato/Ceramica dura/Granito/Marmo
 Porcelain stoneware/Hard ceramic/Granite/Marble
 Gres porcelánico/Cerámica dura/Granito/Mármol



| | | |
|------------------------------|--------------------------|--------------------------------|
| Velocità - Speed - Velocidad | Durata - Life - Duración | Finitura - Finishing - Acabado |
| ★★★★★ | ★★★★☆ | ★★★★☆ |



| Art. | Ø | | M14 * | max mm |
|----------|-----|---------|-------|--------|
| | mm | inch | | |
| FS-TI 6 | 6 | 1/4 | M14 * | 35 |
| FS-TI 8 | 8 | 5/16 | M14 * | 35 |
| FS-TI 10 | 10 | 3/8 | M14 * | 35 |
| FS-TI 12 | 12 | 1/2 | M14 * | 35 |
| FS-TI 14 | 14 | 9/16 | M14 * | 35 |
| FS-TI 16 | 16 | 5/8 | M14 * | 35 |
| FS-TI 18 | 18 | 11/16 | M14 * | 35 |
| FS-TI 20 | 20 | 3/4 | M14 * | 35 |
| FS-TI 25 | 25 | 1 | M14 * | 35 |
| FS-TI 27 | 27 | 1-1/16 | M14 * | 35 |
| FS-TI 30 | 30 | 1-3/16 | M14 * | 35 |
| FS-TI 35 | 35 | 1-3/8 | M14 * | 35 |
| FS-TI 40 | 40 | 1-1/2 | M14 * | 35 |
| FS-TI 45 | 45 | 1-3/4 | M14 * | 35 |
| FS-TI 50 | 50 | 2 | M14 * | 35 |
| FS-TI 55 | 55 | 2-3/16 | M14 * | 35 |
| FS-TI 60 | 60 | 2-3/8 | M14 * | 35 |
| FS-TI 65 | 65 | 2-1/2 | M14 * | 35 |
| FS-TI 68 | 68 | 2-11/16 | M14 * | 35 |
| FS-TI 70 | 70 | 2-3/4 | M14 * | 35 |
| FS-TI 75 | 75 | 3 | M14 * | 35 |
| FS-TI100 | 100 | 4 | M14 * | 35 |
| FS-TI120 | 120 | 4-3/4 | M14 * | 35 |

FS-TI_KIT-IT | Box + FS-TI8 + FS-TI20 + FS-TI27 + FS-TI35 + FS-TI50

* 5/8 inch: Riduzione a richiesta • Reduction on request • Reducción a pedido



Art. FS-TI_KIT-IT

Art. AUFS



Raccordo per trapano - M14
 Adapter for drill - M14
 Racor para taladro - M14

| IT | GB | ES | |
|---|---------------------------------|---|-------|
| Gres porcellanato | Porcelain stoneware | Gres porcelánico | ★★★★★ |
| Piastrelle in granito e pietre naturali | Granite and natural stone tiles | Baldosas de granito y piedras naturales | ★★★★★ |
| Piastrelle in monocottura, granito | Single-fired tiles, granite | Baldosas de cerámica, granito | ★★★★★ |
| Marmo e piastrelle in marmo | Marble and marble tiles | Mármol y baldosas de mármol | ★★★★★ |
| Piastrelle in bicottura e vetrose | Double fired glazed tiles | Baldosas de doble cocción y vítreas | ★★★★☆ |



pg. 94 → Liquido refrigerante
 → Cooling fluid
 Líquido refrigerante

KILLER GRES - SINTERED DRY DRILLING

Gres porcellanato/Ceramica dura/Granito
 Porcelain stoneware/Hard ceramic/Granite
 Gres porcelánico/Cerámica dura/Granito



| | | |
|------------------------------|--------------------------|--------------------------------|
| Velocità - Speed - Velocidad | Durata - Life - Duración | Finitura - Finishing - Acabado |
| ★★★★☆ | ★★★★★ | ★★★★☆ |

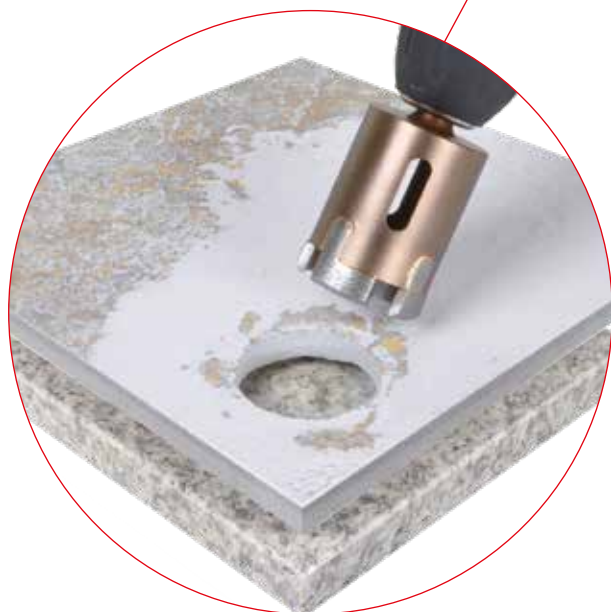

Art.



| Art. | mm | | inch | | max mm |
|-------|-----|--------|------|------|--------|
| | mm | inch | mm | inch | |
| FT 6 | 6 | 1/4 | 10 | 45 | |
| FT 8 | 8 | 5/16 | 10 | 45 | |
| FT 10 | 10 | 3/8 | 10 | 45 | |
| FT 15 | 15 | 5/8 | 10 | 45 | |
| FT 20 | 20 | 3/4 | 10 | 45 | |
| FT 27 | 27 | 1-1/16 | 10 | 45 | |
| FT 35 | 35 | 1-3/8 | 10 | 45 | |
| FT 40 | 40 | 1-1/2 | 10 | 45 | |
| FT 50 | 50 | 2 | 10 | 45 | |
| FT 60 | 60 | 2-3/8 | 10 | 45 | |
| FT 65 | 65 | 2-1/2 | 10 | 45 | |
| FT 75 | 75 | 3 | 10 | 45 | |
| FT100 | 100 | 4 | 10 | 45 | |
| FT120 | 120 | 4-3/4 | 10 | 45 | |

| IT | GB | ES | |
|---|---------------------------------|---|-------|
| Gres porcellanato | Porcelain stoneware | Gres porcelánico | ★★★★★ |
| Piastrelle in granito e pietre naturali | Granite and natural stone tiles | Baldosas de granito y piedras naturales | ★★★★★ |
| Piastrelle in monocottura, granito | Single-fired tiles, granite | Baldosas de cerámica, granito | ★★★★☆ |
| Marmo e piastrelle in marmo | Marble and marble tiles | Mármol y baldosas de mármol | ★★★☆☆ |



pg. 94 → Liquido refrigerante
 → Cooling fluid
 Líquido refrigerante

KILLER GRES - SINTERED DRY DRILLING

Gres porcellanato alto spessore/Ceramica dura/Granito
 Porcelain stoneware high thickness/Hard ceramic/Granite
 Gres porcelánico de gran espesor/Cerámica dura/Granito



| | | |
|------------------------------|--------------------------|--------------------------------|
| Velocità - Speed - Velocidad | Durata - Life - Duración | Finitura - Finishing - Acabado |
| ★★★★★ | ★★★★★ | ★★★★☆ |



Speciale per gres porcellanato alto spessore
 Special for porcelain stoneware high thickness
 Especial para gres porcelánico de alto espesor.

8mm



| Art. | Ø | | MAX | | MAX rpm |
|---------|-----|---------|------|--------|---------|
| | mm | inch | mm | max mm | |
| FT-S 6 | 6 | 1/4 | M14 | 40 | 6.000 |
| FT-S 8 | 8 | 5/16 | M14 | 40 | 6.000 |
| FT-S10 | 10 | 3/8 | M14* | 40 | 6.000 |
| FT-S12 | 12 | 1/2 | M14* | 40 | 6.000 |
| FT-S15 | 15 | 5/8 | M14* | 50 | 12.000 |
| FT-S20 | 20 | 3/4 | M14* | 50 | 12.000 |
| FT-S25 | 25 | 1 | M14* | 50 | 12.000 |
| FT-S27 | 27 | 1-1/16 | M14* | 50 | 12.000 |
| FT-S30 | 30 | 1-3/16 | M14* | 50 | 12.000 |
| FT-S35 | 35 | 1-3/8 | M14* | 50 | 12.000 |
| FT-S40 | 40 | 1-1/2 | M14* | 50 | 12.000 |
| FT-S43 | 43 | 1-11/16 | M14* | 50 | 12.000 |
| FT-S50 | 50 | 2 | M14* | 50 | 12.000 |
| FT-S55 | 55 | 2-3/16 | M14* | 50 | 12.000 |
| FT-S60 | 60 | 2-3/8 | M14* | 50 | 12.000 |
| FT-S65 | 65 | 2-1/2 | M14* | 50 | 12.000 |
| FT-S70 | 70 | 2-3/4 | M14* | 50 | 12.000 |
| FT-S100 | 100 | 4 | M14* | 50 | 4.000 |
| FT-S120 | 120 | 4-3/4 | M14* | 50 | 4.000 |

FTSKIT-IT | Box + FT-S20 + FT-S35 + FT-S50

* 5/8 inch: Riduzione a richiesta • Reduction on request • Reducción a pedido

| IT | GB | ES | |
|---|------------------------------------|---|-------|
| Gres porcellanato alto spessore | Porcelain stoneware high thickness | Gres porcelánico de alto espesor | ★★★★★ |
| Gres porcellanato | Porcelain stoneware | Gres porcelánico | ★★★★★ |
| Piastrelle in granito e pietre naturali | Granite and natural stone tiles | Baldosas de granito y piedras naturales | ★★★★★ |
| Piastrelle in monocottura | Single-fired tiles | Baldosas de cerámica | ★★★★☆ |
| Marmo e piastrelle in marmo | Marble and marble tiles | Mármol y baldosas de mármol | ★★★☆☆ |



pg. 94 → Liquido refrigerante
 → Cooling fluid
 → Líquido refrigerante

pg. 107 → Espositore
 → Display
 → Expositor



MANGIATUTTO - SINTERED WET DRILLING

Gres porcellanato/Ceramica/Monocottura/Granito/Marmo
 Porcelain stoneware/Ceramic/Single fired tile/Granite/Marble
 Gres porcelánico/Cerámica/Monocuisson/Granito/Mármol



| | | |
|------------------------------|--------------------------|--------------------------------|
| Velocità - Speed - Velocidad | Durata - Life - Duración | Finitura - Finishing - Acabado |
| ★★★★☆ | ★★★★★ | ★★★★★ |

| Art. | | | | |
|------|----|------|----|--------|
| | mm | inch | mm | max mm |
| MU 5 | 5 | 3/16 | 10 | 45 |
| MU 6 | 6 | 1/4 | 10 | 45 |
| MU 8 | 8 | 5/16 | 10 | 45 |
| MU10 | 10 | 3/8 | 10 | 45 |
| MU12 | 12 | 1/2 | 10 | 45 |
| MU14 | 14 | 9/16 | 10 | 45 |

| IT | GB | ES | |
|---|---------------------------------|---|-------|
| Piastrelle in monocottura, granito | Single-fired tiles, granite | Baldosas de cerámica, granito | ★★★★★ |
| Piastrelle in granito e pietre naturali | Granite and natural stone tiles | Baldosas de granito y piedras naturales | ★★★★★ |
| Piastrelle in bicottura e vetrose | Double fired glazed tiles | Baldosas de doble cocción y vítreas | ★★★★★ |
| Gres porcellanato | Porcelain stoneware | Gres porcelánico | ★★★★★ |
| Marmo e piastrelle in marmo | Marble and marble tiles | Mármol y baldosas de mármol | ★★★★☆ |

SINTERIZED - WET DRILLING

Piastrelle in vetro/Ceramica delicata
 Glass tiles/Soft ceramic
 Baldosas de vidrio/Cerámicas delicadas

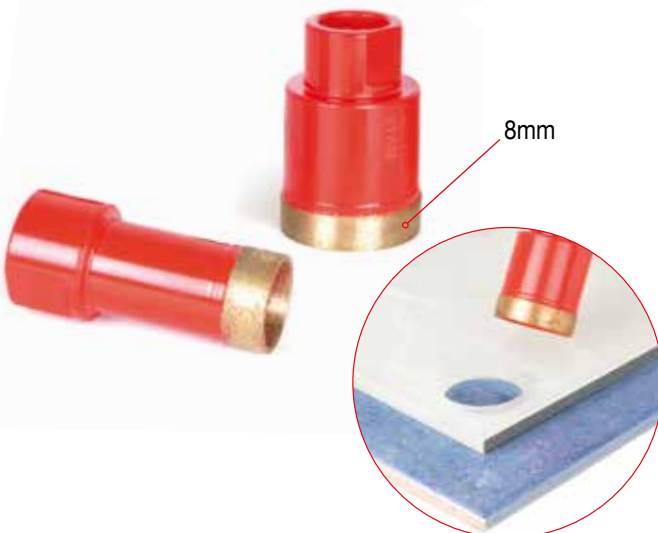

| | | |
|------------------------------|--------------------------|--------------------------------|
| Velocità - Speed - Velocidad | Durata - Life - Duración | Finitura - Finishing - Acabado |
| ★★★★☆ | ★★★★☆ | ★★★★★ |

| Art. | | | | |
|-------|----|--------|-----|--------|
| | mm | inch | | max mm |
| FAV20 | 20 | 3/4 | M16 | 30 |
| FAV28 | 28 | 1-1/16 | M16 | 30 |
| FAV35 | 35 | 1-3/8 | M16 | 30 |
| FAV51 | 51 | 2 | M16 | 30 |
| FAV65 | 65 | 2-1/2 | M16 | 30 |

| IT | GB | ES | |
|-----------------------------------|---------------------------|-----------------------------|-------|
| Piastrelle in vetro | Glass tiles | Baldosas de vidrio | ★★★★★ |
| Piastrelle in bicottura e vetrose | Double fired glazed tiles | Baldosas de doble cocción | ★★★★★ |
| Gres porcellanato | Porcelain stoneware | Gres porcelánico | ★★★★☆ |
| Marmo e piastrelle in marmo | Marble and marble tiles | Mármol y baldosas de mármol | ★★★★☆ |



SINTERIZED - WET DRILLING

Gres porcellanato/Ceramica/Monocottura/Granito/Marmo
 Porcelain stoneware/Ceramic/Single fired tile/Granite/Marble
 Gres porcelánico/Cerámica/Monocuisson/Granito/Mármol



| | | |
|------------------------------|--------------------------|--------------------------------|
| Velocità - Speed - Velocidad | Durata - Life - Duración | Finitura - Finishing - Acabado |
| ★★★★☆ | ★★★★☆ | ★★★★☆ |



| Art. | Ø | | M | max mm |
|-------|-----|--------|-----|--------|
| | mm | inch | | |
| FA 20 | 20 | 3/4 | M16 | 45 |
| FA 27 | 27 | 1-1/16 | M16 | 45 |
| FA 30 | 30 | 1-3/16 | M16 | 45 |
| FA 32 | 32 | 1-1/4 | M16 | 45 |
| FA 35 | 35 | 1-3/8 | M16 | 45 |
| FA 40 | 40 | 1-1/2 | M16 | 45 |
| FA 45 | 45 | 1-3/4 | M16 | 45 |
| FA 50 | 50 | 2 | M16 | 45 |
| FA 55 | 55 | 2-3/16 | M16 | 45 |
| FA 60 | 60 | 2-3/8 | M16 | 45 |
| FA 65 | 65 | 2-1/2 | M16 | 45 |
| FA 70 | 70 | 2-3/4 | M16 | 45 |
| FA 75 | 75 | 3 | M16 | 45 |
| FA100 | 100 | 4 | M16 | 45 |
| FA120 | 120 | 4-3/4 | M16 | 45 |

| | |
|-------|--|
| VAF01 | BOX + 88 + FA20 + FA27 + FA30 + FA35 + FA40+ FA45 + FA50 + FA65 + FA75 + FA100 + FA120 |
| VAF01 | BOX |

| IT | GB | ES | |
|------------------------------------|-----------------------------|-------------------------------|-------|
| Gres porcellanato | Porcelain stoneware | Gres porcelánico | ★★★★★ |
| Piastrelle in monocottura, granito | Single-fired tiles, granite | Baldosas de cerámica, granito | ★★★★★ |
| Marmo e piastrelle in marmo | Marble and marble tiles | Mármol y baldosas de mármol | ★★★★★ |
| Piastrelle in bicottura e vetrose | Double fired glazed tiles | Baldosas de doble cocción | ★★★★★ |
| Granito, pietre naturali | Granite, natural stone | Granito, piedras naturales | ★★★★☆ |

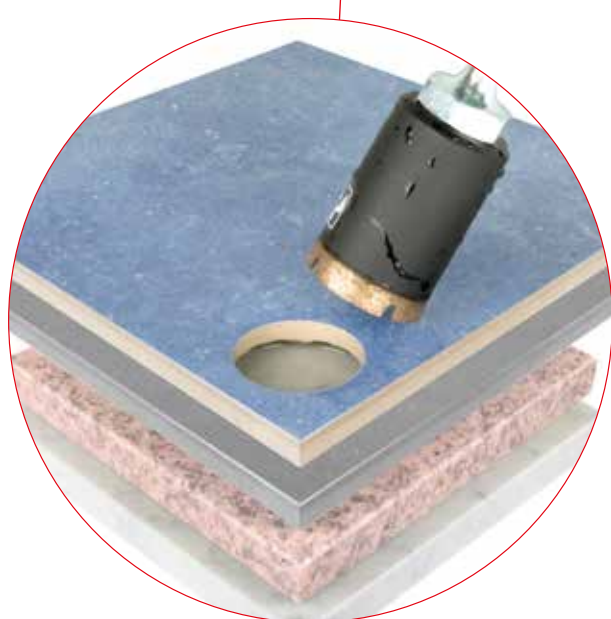

| | | | | | | |
|-----------|--|---------|--|------------|--|----------|
| Art. AUFA | | Art. 88 | | Art. VTKIT | | pg. 96 → |
|-----------|--|---------|--|------------|--|----------|

MONDRILLO PERFORMER

Art. M-Performer

- IT Fluido refrigerante per prestazioni ottimali delle punte diamantate.
- GB Cooling fluid for optimal performance of diamond core bits.
- ES Líquido refrigerante para el rendimiento óptimo de puntas de diamante.



STONE SUPERCUT

- IT Ravvivatori per utensili diamantati
- GB Grindstone for dressing diamond tools
- ES Piedra de afilar para herramientas diamantadas



Art.

| | | |
|--------|---|--|
| 395-2U | Special Multipurpose (206 x 73 x 30 mm) | |
| 395BJ | Junior (80 x 50 x 20 mm) | |

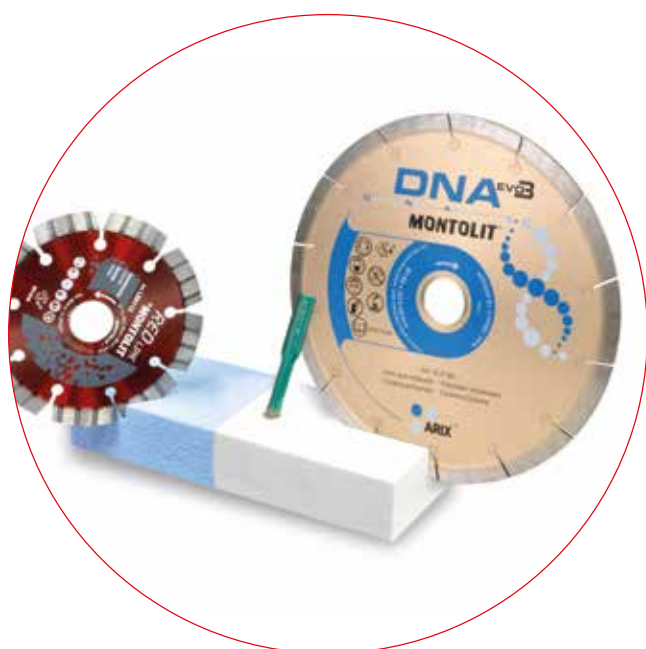

Art. 395BJ



Art. 395-2U

SAFE DIAMOND BOX

Art. SDB

- IT Custodia protettiva per utensili diamantati.
- GB Safe case for diamond tools.
- ES Caja para herramientas diamantadas.



JUNIOR SAFE DIAMOND BOX

NEW

Art. SDB JUNIOR

- IT Custodia protettiva per utensili diamantati.
- GB Safe case for diamond tools.
- ES Caja para herramientas diamantadas.



ACCESSORI PER LA FORATURA AD ACQUA

EQUIPMENT FOR WET DRILLING - EQUIPOS PARA LA PERFORACIÓN CON AGUA

| | | |
|-------------------|---|--|
| Art. PS92 | Raccordo portapunta per MU (x artt. 915/916/CVG12) Drill-holder connector for MU (x artt. 915/916/CVG12) Enganche portapunta MU (x artt. 915/916/CVG12) |  |
| Art. AUFA | Raccordo per trapano - M16 (x artt. FA/FAV) Adapter for drill - M16 (x artt. FA/FAV) Adaptador para taladro - M16 (x artt. FA/FAV) |  |
| Art. 88 | Mandrino a punta centrale retraente - M16 (x artt. FA/FAV) Arbor with central retractable bit - M16 (x artt. FA/FAV) Mandril con punta central retráctil - M16 (x artt. FA/FAV) |  |
| Art. CVG12 | Convogliatore d'acqua completo di tanica Water feed complete with jerry Depósito de agua con bidón |  |
| Art. VTKIT | Ventose per foratura con acqua (Ø 40mm + Ø 60mm) Suction cups for water drilling (Ø 40mm + Ø 60mm) Ventosas para perforación con agua (Ø 40mm + Ø 60mm) |  |
| Art. 89 | Riduzione M16 - G 1/2" M16 - G 1/2" adapter Adaptador M16 - G 1/2" |  |

GUIDA ALLA SCELTA DI FRESE E PUNTE DIAMANTATE

SELECTION GUIDE OF DIAMOND CORE-BITS • GUÍA PARA LA ELECCIÓN DE FRESAS Y PUNTAS DIAMANTADAS

|  | MOD. | UTILIZZO / USE / USAR |
|---|---------------------------------|---|
| mm 4 | FAJ | tasselli / wall plugs / tacos de pared |
| inch 5/32 | FAJ / FTJ / MU | tasselli / wall plugs / tacos de pared |
| mm 5 | FAJ / FS / FTJ / FT-S / MU | tasselli / wall plugs / tacos de pared |
| inch 3/16 | FAJ / FS / FTJ / FT-S / MU | tasselli / wall plugs / tacos de pared |
| mm 6 | FAJ / FS / FTJ / FT-S / MU | tasselli / wall plugs / tacos de pared |
| inch 1/4 | FAJ / FS / FTJ / FT-S / MU | tasselli / wall plugs / tacos de pared |
| mm 8 | FAJ / FS / FTJ / FT-S / MU | tasselli / wall plugs / tacos de pared |
| inch 5/16 | FAJ / FS / FTJ / FT-S / MU | tasselli / wall plugs / tacos de pared |
| mm 10 | FAJ / FS / FTJ / FT-S / FT / MU | tasselli / wall plugs / tacos de pared |
| inch 3/8 | FAJ / FS / FTJ / FT-S / FT / MU | tasselli / wall plugs / tacos de pared |
| mm 12 | FAJ / FS / FTJ / FT-S / MU | tasselli, fermaporta / wall plugs, door stopper / tacos de pared, tope de puerta |
| inch 1/2 | FAJ / FS / FTJ / FT-S / MU | tasselli, fermaporta / wall plugs, door stopper / tacos de pared, tope de puerta |
| mm 14 | FS / MU | tasselli, fermaporta / wall plugs, door stopper / tacos de pared, tope de puerta |
| inch 9/16 | FS / MU | tasselli, fermaporta / wall plugs, door stopper / tacos de pared, tope de puerta |
| mm 15 | FT / FT-S | tubo 1/4", tasselli, fermaporta / 1/4" tube, wall plugs, door stopper / tubería 1/4, tacos de pared, tope de puerta |
| inch 5/8 | FT / FT-S | tubo 1/4", tasselli, fermaporta / 1/4" tube, wall plugs, door stopper / tubería 1/4, tacos de pared, tope de puerta |
| mm 16 | FS | incasso porte blindate / recess armored doors / puertas blindadas empotradas |
| inch 5/8 | FS | incasso porte blindate / recess armored doors / puertas blindadas empotradas |
| mm 18 | FS | tubo 3/8" in rame per gas, acqua / 3/8" copper tube for gas, water / tubería de cobre de 3/8 para gas, agua |
| inch 11/16 | FS | tubo 3/8" in rame per gas, acqua / 3/8" copper tube for gas, water / tubería de cobre de 3/8 para gas, agua |
| mm 20 | FA / FS / FT / FT-S / FAV | tubo 3/8" in rame per gas, acqua / 3/8" copper tube for gas, water / tubería de cobre de 3/8 para gas, agua |
| inch 3/4 | FA / FS / FT / FT-S / FAV | tubo 3/8" in rame per gas, acqua / 3/8" copper tube for gas, water / tubería de cobre de 3/8 para gas, agua |
| mm 25 | FS / FT-S | tubo 1/2" acqua, rubinetti, riscaldamento, civile / 1/2" tube fucets system, heating system / 1/2" tubería de agua, grifos, calefacción, civil |
| inch 1 | FS / FT-S | tubo 1/2" acqua, rubinetti, riscaldamento, civile / 1/2" tube fucets system, heating system / 1/2" tubería de agua, grifos, calefacción, civil |
| mm 27 | FA / FS / FT / FT-S / FAV | tubo 1/2" acqua, rubinetti, riscaldamento, civile / 1/2" tube fucets system, heating system / 1/2" tubería de acqua, grifos, calefacción, civil |
| inch 1-1/16 | FA / FS / FT / FT-S / FAV | tubo 1/2" acqua, rubinetti, riscaldamento, civile / 1/2" tube fucets system, heating system / 1/2" tubería de acqua, grifos, calefacción, civil |
| mm 30 | FA / FS / FT-S | tubo 3/4" acqua, rubinetti, riscaldamento, civile / 3/4" tube fucets system, heating system / 3/4" tubería de acqua, grifos, calefacción, civil |
| inch 1-3/16 | FA / FS / FT-S | tubo 3/4" acqua, rubinetti, riscaldamento, civile / 3/4" tube fucets system, heating system / 3/4" tubería de acqua, grifos, calefacción, civil |
| mm 32 | FA | tubo 3/4" acqua, rubinetti, riscaldamento, civile / 3/4" tube fucets system, heating system / 3/4" tubería de acqua, grifos, calefacción, civil |
| inch 1-1/4 | FA | tubo 3/4" acqua, rubinetti, riscaldamento, civile / 3/4" tube fucets system, heating system / 3/4" tubería de acqua, grifos, calefacción, civil |
| mm 35 | FA / FS / FT / FT-S | tubo 1" ferro o pvc per acqua, gas, industriale / 1" iron or pvc tube for water, gas, industrial use / tubería de hierro o pvc de 1" para agua, gas, industrial |
| inch 1-3/8 | FA / FS / FT / FT-S | tubo 1" ferro o pvc per acqua, gas, industriale / 1" iron or pvc tube for water, gas, industrial use / tubería de hierro o pvc de 1" para agua, gas, industrial |
| mm 40 | FA / FS / FT / FT-S | tubo 1" ferro o pvc per acqua, gas, industriale / 1" iron or pvc tube for water, gas, industrial use / tubería de hierro o pvc de 1" para agua, gas, industrial |
| inch 1-1/2 | FA / FS / FT / FT-S | tubo 1" ferro o pvc per acqua, gas, industriale / 1" iron or pvc tube for water, gas, industrial use / tubería de hierro o pvc de 1" para agua, gas, industrial |
| mm 43 | FT-S | tubo 1-1/4" scarico lavello, lavandino, lavastoviglie / 1-1/4" drainage system for bathroom, kitchen, sink / tubo de desagüe de 1-1/4" lavabo, fregadero, lavavajillas |
| inch 1-11/16 | FT-S | tubo 1-1/4" scarico lavello, lavandino, lavastoviglie / 1-1/4" drainage system for bathroom, kitchen, sink / tubo de desagüe de 1-1/4" lavabo, fregadero, lavavajillas |
| mm 45 | FA / FS | tubo 1-1/4" scarico lavello, lavandino, lavastoviglie / 1-1/4" drainage system for bathroom, kitchen, sink / tubo de desagüe de 1-1/4" lavabo, fregadero, lavavajillas |
| inch 1-3/4 | FA / FS | tubo 1-1/4" scarico lavello, lavandino, lavastoviglie / 1-1/4" drainage system for bathroom, kitchen, sink / tubo de desagüe de 1-1/4" lavabo, fregadero, lavavajillas |
| mm 50 | FA / FS / FT / FT-S / FAV | tubo 1-1/4" scarico lavello, lavandino, lavastoviglie / 1-1/4" drainage system for bathroom, kitchen, sink / tubo de desagüe de 1-1/4" lavabo, fregadero, lavavajillas |
| inch 2 | FA / FS / FT / FT-S / FAV | tubo 1-1/4" scarico lavello, lavandino, lavastoviglie / 1-1/4" drainage system for bathroom, kitchen, sink / tubo de desagüe de 1-1/4" lavabo, fregadero, lavavajillas |
| mm 55 | FA / FS / FT-S | tubo 1-1/2" scarico lavatrice / 1-1/2" waste pipe for washing machine, drain system / tubo de desagüe de lavadora de 1-1/2" |
| inch 2-3/16 | FA / FS / FT-S | tubo 1-1/2" scarico lavatrice / 1-1/2" waste pipe for washing machine, drain system / tubo de desagüe de lavadora de 1-1/2" |
| mm 60 | FA / FS / FT / FT-S | tubo 1-1/2" scarico lavatrice / 1-1/2" waste pipe for washing machine, drain system / tubo de desagüe de lavadora de 1-1/2" |
| inch 2-3/8 | FA / FS / FT / FT-S | tubo 1-1/2" scarico lavatrice / 1-1/2" waste pipe for washing machine, drain system / tubo de desagüe de lavadora de 1-1/2" |
| mm 65 | FA / FS / FT / FT-S / FAV | tubo 1-1/2" scarico lavatrice / 1-1/2" waste pipe for washing machine, drain system / tubo de desagüe de lavadora de 1-1/2" |
| inch 2-1/2 | FA / FS / FT / FT-S / FAV | tubo 1-1/2" scarico lavatrice / 1-1/2" waste pipe for washing machine, drain system / tubo de desagüe de lavadora de 1-1/2" |
| mm 68 | FS | faretto ad incasso, tubo 2" / recessed spotlight, 2" tube / focos empotrables, tubo de 2" |
| inch 2-11/16 | FS | faretto ad incasso, tubo 2" / recessed spotlight, 2" tube / focos empotrables, tubo de 2" |
| mm 70 | FA / FS / FT-S | tubo 2" scarico lavatrici industriali, raccordi pvc, piscine / 2" waste pipe for washing machine, pvc connection pipe and swimmingpool / tubo de desagüe de 2" lavadoras industriales, conexiones de pvc, piscinas |
| inch 2-3/4 | FA / FS / FT-S | tubo 2" scarico lavatrici industriali, raccordi pvc, piscine / 2" waste pipe for washing machine, pvc connection pipe and swimmingpool / tubo de desagüe de 2" lavadoras industriales, conexiones de pvc, piscinas |
| mm 75 | FA / FS / FT | tubo 2" o 2-1/2" scarico lavatrici industriali, raccordi pvc, piscine / 2" o 2-1/2" waste pipe for washing machine, pvc connection pipe and swimmingpool / tubo de desagüe de 2" o 2-1/2" lavadoras industriales, conexiones de pvc, piscinas |
| inch 3 | FA / FS / FT | tubo 2" o 2-1/2" scarico lavatrici industriali, raccordi pvc, piscine / 2" o 2-1/2" waste pipe for washing machine, pvc connection pipe and swimmingpool / tubo de desagüe de 2" o 2-1/2" lavadoras industriales, conexiones de pvc, piscinas |
| mm 100 | FA / FS / FT / FT-S | tubo 3" scarico wc, presa aria cucina - caldaia / 3" flushing system pipe for wc, ventilation outlet for kitchen-boiler / 3" tubería de desagüe del wc, toma de ventilación de la cocina - calentador |
| inch 4 | FA / FS / FT / FT-S | tubo 3" scarico wc, presa aria cucina - caldaia / 3" flushing system pipe for wc, ventilation outlet for kitchen-boiler / 3" tubería de desagüe del wc, toma de ventilación de la cocina - calentador |
| mm 120 | FA / FS / FT / FT-S | presa aria cucina - caldaia / ventilation outlet for kitchen-boiler / toma de ventilación de la cocina - calentador |
| inch 4-3/4 | FA / FS / FT / FT-S | presa aria cucina - caldaia / ventilation outlet for kitchen-boiler / toma de ventilación de la cocina - calentador |

Lavorazioni speciali
Special works
Obras especiales

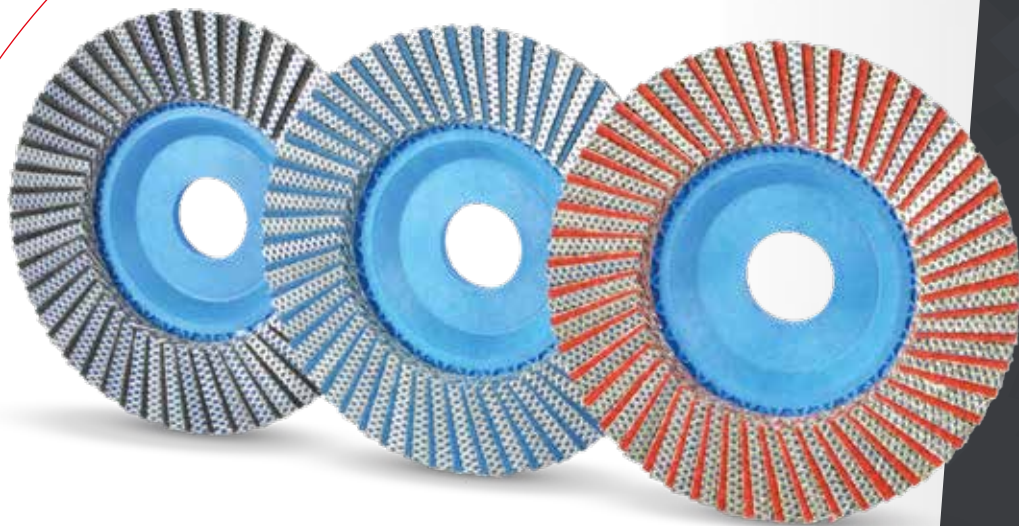

MONDRILLO

IT Fresa diamantata universale per allargare e sagomare i fori
GB Universal diamond milling bit for enlarging and shaping holes
ES Fresa diamantada universal para ensanchar, o dar forma a perforaciones



Art. FPU20

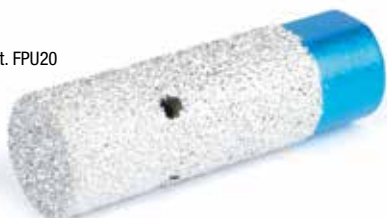

| Art. | | | | |
|-------|----|------|------|----|
| | mm | inch | | |
| FPUS6 | 6 | 1/4 | M14* | 35 |
| FPU20 | 20 | 3/4 | M14* | 50 |

* 5/8 inch: Riduzione a richiesta • Reduction on request • Reducción a pedido

Gres porcellanato/Ceramica/Granito/Marmo/Vetro
 Porcelain stoneware/Ceramic/Granite/Marble/Glass
 Gres porcelánico/Cerámica/Granito/Mármol/Vidrio



MONDRILLO

IT Frese coniche diamantate a profilo svasatore per la rifinitura dei fori
GB Diamond countersink tool (dry or wet use) for finishing holes
ES Fresas cónicas diamantadas con perfil de avellanador para el pulido de los orificios



Art. FPS75

Art. FPS35



| Art. | | | |
|-------|---------|--------------|------|
| | mm | inch | |
| FPS35 | 5 ÷ 35 | 3/16 ÷ 1-3/8 | M14* |
| FPS75 | 35 ÷ 75 | 1-3/8 ÷ 3 | M14* |

* 5/8 inch: Riduzione a richiesta • Reduction on request • Reducción a pedido

Gres porcellanato/Ceramica/Granito/Marmo/Vetro
 Porcelain stoneware/Ceramic/Granite/Marble/Glass
 Gres porcelánico/Cerámica/Granito/Mármol/Vidrio



MONDRILLO

- IT Mola diamantata per "piletta lavabo"
- GB Diamond grinding wheel for "sink drain"
- ES Muela de diamante para desagüe de lavabo

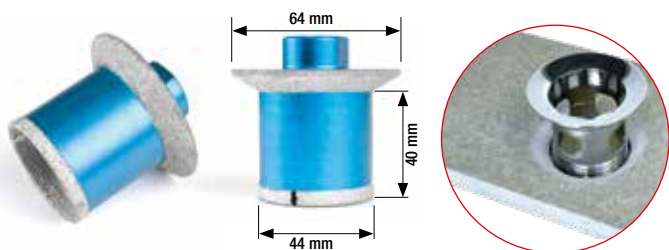

| | | |
|-------|-------|--|
| Art. | M14 * | |
| FP-PI | | |

* 5/8 inch: Riduzione a richiesta • Reduction on request • Reducción a pedido

Gres porcellanato/Granito/Marmo/Resine sintetiche
 Porcelain stoneware/Granite/Marble/Synthetic resins
 Gres porcelánico/Granito/Mármol/Resinas sintéticas

MONDRILLO - AFTERCUT

- IT Profilatore antirottura
- GB Edge cleaner
- ES Perfilador anti-rotura



| | | |
|----------|-------|--|
| Art. | M14 * | |
| AFTERCUT | | |

* 5/8 inch: Riduzione a richiesta • Reduction on request • Reducción a pedido

Gres porcellanato/Ceramica
 Porcelain stoneware/Ceramic
 Gres porcelánico/Cerámica

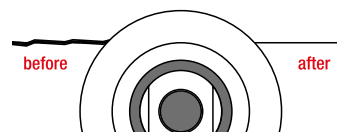

MONDRILLO

- IT Scontornatori diamantati
- GB Diamond bevel profiles
- ES Herramienta diamantada para perfiles

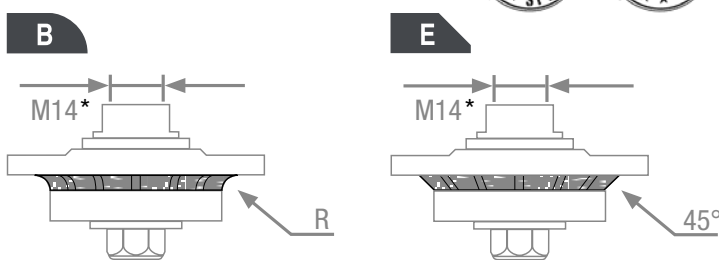

Gres porcellanato/Granito/Marmo
 Porcelain stoneware/Granite/Marble
 Gres porcelánico/Granito/Mármol

| Art. | Tipo / type / tipo |
|-------|--------------------|
| B03 | B = R 3mm |
| B05 | B = R 5mm |
| B10 | B = R 10mm |
| E03 | E = 45° 3mm |
| E05 | E = 45° 5mm |
| B03-D | B = R 3mm |
| B05-D | B = R 5mm |
| B10-D | B = R 10mm |
| E03-D | E = 45° 3mm |
| E05-D | E = 45° 5mm |

* 5/8 inch: Riduzione a richiesta • Reduction on request • Reducción a pedido



MONDRILLO



IT Mola diamantata per profilo tipo "V"
 GB Diamond grinding wheel for "V" type profile
 ES Muela de diamante para perfil tipo "V"



V

| | | |
|-------|------------------------|------|
| Art. | | |
| FPV22 | "V" Profile - R = 22mm | M14* |

* 5/8 inch: Riduzione a richiesta • Reduction on request • Reducción a pedido

Gres porcellanato/Granito/Marmo
 Porcelain stoneware/Granite/Marble
 Gres porcelánico/Granito/Mármol



MONDRILLO

IT Mola diamantata per profilo antiscivolo
 GB Diamond grinding wheel for non slip profile
 ES Muela de diamante para perfil antideslizante



| | | |
|-------|----------------------|------|
| Art. | | |
| FP-AS | 20+20mm (3/4 + 3/4") | M14* |

* 5/8 inch: Riduzione a richiesta • Reduction on request • Reducción a pedido

Gres porcellanato/Granito/Marmo
 Porcelain stoneware/Granite/Marble
 Gres porcelánico/Granito/Mármol



MONDRILLO

IT Mola diamantata per "gocciolatoio"
 GB Diamond grinding wheel for "drip"
 ES Muela de diamante para "goteo"

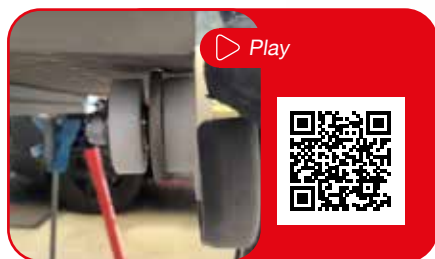

| | | |
|-------|--|------|
| Art. | | |
| FP-GO | | M14* |

* 5/8 inch: Riduzione a richiesta • Reduction on request • Reducción a pedido

Gres porcellanato/Granito/Marmo
 Porcelain stoneware/Granite/Marble
 Gres porcelánico/Granito/Mármol

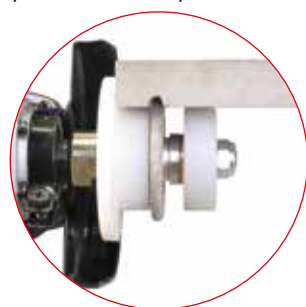

PADS

IT Platorelli diamantati resinoidi con attacco velcro™ per la levigatura e lucidatura. Gres porcellanato/Granito/Marmo/Vetro.

GB Diamond resin polishing pads with Velcro coupling for grinding and polishing - Porcelain stoneware/Granite/Marble/Glass.

ES Almohadillas de pulido de resina de diamante - con unión Velcro™ - para el esmerilado y pulido - Gres porcelánico/Granito/Mármol/Vidro



Art.

| | | |
|--------|------------------|--|
| PDR | M14* | |
| PDR 0 | Step "0" | |
| PDR 1 | Step "1" | |
| PDR 2 | Step "2" | |
| PDR 3 | Step "3" | |
| PDRKIT | Step "1 + 2 + 3" | |

* 5/8 inch: Riduzione a richiesta • Reduction on request • Reducción a pedido

Art. PDRKIT



Art. PDR



Art. PDR0



MASTERTECH

IT Tamponi diamantati per sgrossare e rifinire

GB Diamond hand pads for smoothing the edges

ES Almohadillas de diamante para el pulido y acabado



Art.

| | | |
|-------|--|--|
| DT262 | B blister: 1 art. DT060 + 1 art. DT200 | |
| DT606 | Box: 6 artt. DT060 - Medium | |
| DT620 | Box: 6 artt. DT200 - Fine | |

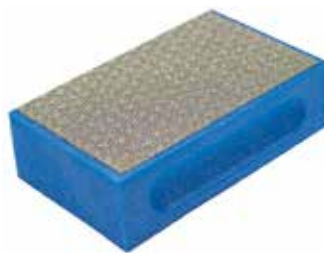

Art. DT200 - Fine

Monocottura/Bicottura/Marmo/Vetro
Ceramic/Double fired tile/Marble/Glass
Monococción/Doble cocción/Mármol/Vidro

Art. DT060 - Medium

Gres porcellanato/Klinker/Granito
Porcelain stoneware/Klinker/Granit
Gres porcelánico/Klinker/Granito

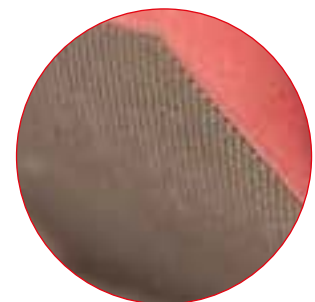
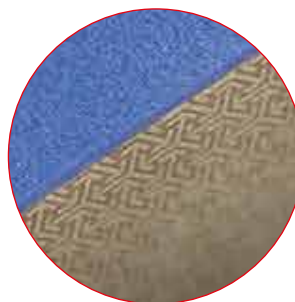

Art.

| Art. | Grana / Grain / Grano | Color |
|--------|-----------------------|--------|
| DF60 | 60 | Green |
| DF120 | 120 | Black |
| DF200 | 200 | Red |
| DF400 | 400 | Yellow |
| DF500 | 500 | White |
| DF1500 | 1500 | Blue |
| DF3000 | 3000 | Orange |

MONDRILLO

NEW 2025

IT Mole diamantate per taglio e levigatura
 GB Diamond cup wheels for cutting and grinding
 ES Muelas de diamante para el cortar y rectificar



Gres porcellanato/Ceramica delicata/Marmo/Vetro
 Porcelain stoneware/Soft ceramic/Marble/Glass
 Gres porcelánico/Cerámicas delicadas/Mármol/Vidrio

FINE

| Art. | \varnothing | \varnothing | \varnothing |
|------------|---------------|---------------|---------------|
| | mm | inch | mm * |
| STL115GF-M | 115 | 4,5 | 22,2 |
| STL125GF-M | 125 | 5 | 22,2 |

* 5/8 inch: Riduzione a richiesta • Reduction on request • Reducción a pedido



Gres porcellanato/Granito/Pietra/Cemento
 Porcelain stoneware/Granite/Stone/Concrete
 Gres porcelánico/Granito/Piedra/Hormigón

MEDIUM

| Art. | \varnothing | \varnothing | \varnothing |
|------------|---------------|---------------|---------------|
| | mm | inch | mm * |
| STL115GG-M | 115 | 4,5 | 22,2 |
| STL125GG-M | 125 | 5 | 22,2 |

* 5/8 inch: Riduzione a richiesta • Reduction on request • Reducción a pedido

MONDRILLO

IT Platorelli diamantati multiuso
 GB Diamond multipurpose grinding wheels
 ES Platos diamantados multiuso



FINE

Gres porcellanato/Ceramica delicata/Marmo/Vetro
 Porcelain stoneware/Soft ceramic/Marble/Glass
 Gres porcelánico/Cerámicas delicadas/Mármol/Vidrio

| Art. | \varnothing | \varnothing | \varnothing |
|-----------|---------------|---------------|---------------|
| | mm | inch | mm |
| PE115GF | 115 | 4,5 | 22,2 * |
| PEBS115GF | 115 | 4,5 | M14 |

* 5/8 inch: Riduzione a richiesta • Reduction on request • Reducción a pedido

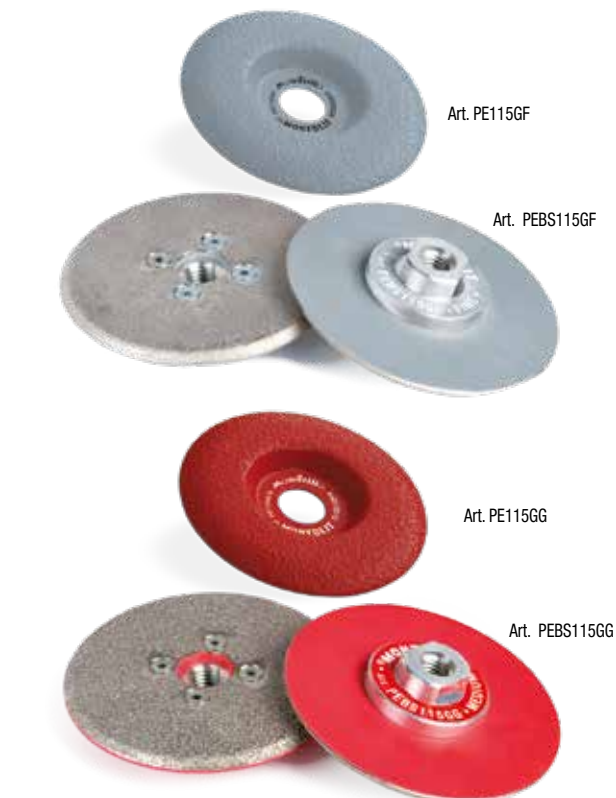

Gres porcellanato/Granito/Pietra/Cemento/Mattoni
 Porcelain stoneware/Granite/Stone/Concrete/Bricks
 Gres porcelánico/Granito/Piedra/Hormigón

MEDIUM

| Art. | \varnothing | \varnothing | \varnothing |
|-----------|---------------|---------------|---------------|
| | mm | inch | mm |
| PE115GG | 115 | 4,5 | 22,2 * |
| PEBS115GG | 115 | 4,5 | M14 |

* 5/8 inch: Riduzione a richiesta • Reduction on request • Reducción a pedido

FLEXIMONT

IT Dischi diamantati lamellari
 GB Lamellar diamond blades
 ES Discos de diamante lamelar



pg. 107
 Espositore
 Display
 Expositor

| Art. | Grana / Grain / Grueso | Ø | | Ø |
|-------------|--------------------------|-----|------|------|
| | | mm | inch | mm * |
| FLEXIMONTGG | grossa / coarse / grueso | 115 | 4,5 | 22,2 |
| FLEXIMONTGM | media / medium / medio | 115 | 4,5 | 22,2 |
| FLEXIMONTGF | fine / fine / fino | 115 | 4,5 | 22,2 |

* 5/8 inch: Riduzione a richiesta • Reduction on request • Reducción a pedido

Gres porcellanato/Ceramica/Granito/Marmo/Vetro
 Porcelain stoneware/Ceramic/Granite/Marble/Glass
 Gres porcelánico/Cerámica/Granito/Mármol/Vidro



FLEXIMONT - Super Aluminium

IT Dischi diamantati lamellari
 GB Lamellar diamond blades
 ES Discos de diamante lamelar



| Art. | Grana / Grain / Grueso | Ø | | Ø |
|----------------|--------------------------|-----|------|------|
| | | mm | inch | mm * |
| FLEXIMONT-S-GG | grossa / coarse / grueso | 115 | 4,5 | 22,2 |
| FLEXIMONT-S-GM | media / medium / medio | 115 | 4,5 | 22,2 |
| FLEXIMONT-S-GF | fine / fine / fino | 115 | 4,5 | 22,2 |

* 5/8 inch: Riduzione a richiesta • Reduction on request • Reducción a pedido

Gres porcellanato/Ceramica/Granito/Marmo/Vetro
 Porcelain stoneware/Ceramic/Granite/Marble/Glass
 Gres porcelánico/Cerámica/Granito/Mármol/Vidro

Corpo in alluminio
 Aluminium body
 Marco de aluminio



MONDRILLO

- IT Platorello per rimozione colla ed epossidico
 GB Diamond cup wheel remover for glue and epoxy
 ES Plato para retiro de pegamento y epoxídico



| Art. | | | | |
|--------|-----|------|------|--|
| | mm | inch | mm* | |
| PEM115 | 115 | 4,5 | 22,2 | |
| PEM125 | 125 | 5 | 22,2 | |

* 5/8 inch: Riduzione a richiesta • Reduction on request • Reducción a pedido

Adesivo/Colla/Epossidico/Guaina/Intonaci/Resine
 Adhesive/Glue/Epoxy Resin/Sheaths/Plasters/Resins
 Adhesivo/Pegamento/Resina Epoxi/Vainas/Recubrimientos/Resinas



PLUME

- IT Mola diamantata sinterizzata per levigatura
 GB Sinterized diamond grinding cup wheel
 ES Muela de diamante sinterizada para el pulido



Speciale per macchine a batteria
 Special for cordless machine
 Especial para máquinas de batería



| Art. | | | | | |
|----------|-----|------|-----|-----|--|
| | mm | inch | mm* | g | |
| PLUME100 | 100 | 4 | M14 | 144 | |
| PLUME125 | 125 | 5 | M14 | 216 | |

* 5/8 inch: Riduzione a richiesta • Reduction on request • Reducción a pedido

Edilizia/Gres Porcellanato/Granito
 Building Material/Porcelain Stoneware/Granite
 Construcción/Gres Porcelánico/Granito



Corpo in polimero ultraleggero
 Body in ultralight polymer
 Montura de polimero ultra ligero

TRITONE

- IT Mole diamantate sinterizzate per levigatura
- GB Sinterized diamond grinding cup wheels
- ES Muelas de diamante sinterizada para el pulido



| Art. | | | |
|------------|-----|------|--------|
| | mm | inch | |
| TRITONE100 | 100 | 4 | M14 |
| TRITONE115 | 115 | 4,5 | 22,2 * |
| TRITONE125 | 125 | 5 | 22,2 * |
| TRITONE150 | 150 | 6 | 22,2 * |
| TRITONE180 | 180 | 7 | 22,2 * |

* 5/8 inch: Riduzione a richiesta • Reduction on request • Reducción a pedido

Calcestruzzo/Materiali lapidei/Gres porcellanato/Rimozione colla e epossidico

Concrete/Stone materials/Porcelain stoneware/Glue and epoxy removal

Hormigón/Materiales pétreos/Gres porcelánico/Eliminación de pegamento y epoxi



VORTEX

- IT Platorello universale scheletrato
- GB Universal diamond cup wheel
- ES Plato universal



| Art. | | | |
|---------|-----|------|--------|
| | mm | inch | |
| PUSV125 | 125 | 5 | 22,2 * |
| PUSV150 | 150 | 6 | 22,2 * |
| PUSV180 | 180 | 7 | 22,2 * |

* 5/8 inch: Riduzione a richiesta • Reduction on request • Reducción a pedido

Calcestruzzo/Materiali lapidei

Concrete/Stone materials

Hormigón - Materiales pétreos



Adattatore 22,2mm / M14
Adapter 22,2mm / M14
Racor 22,2mm / M14

Art. AUM14

TURBO

IT Mole diamantate per levigatura
 GB Diamond grinding cup wheels
 ES Muelas de diamante para el pulido



| Art. | Ø | | Ø | |
|--------|-----|------|--------|--|
| | mm | inch | mm | |
| PUT115 | 115 | 4,5 | 22,2 * | |
| PUT125 | 125 | 5 | 22,2 * | |

* 5/8 inch: Riduzione a richiesta • Reduction on request • Reducción a pedido

Granito/Calcestruzzo - Granite/Concrete - Granito/Hormigón

Art. AUM14



Adattatore 22,2mm / M14
 Adapter 22,2mm / M14
 Racor 22,2mm / M14

SECTOR

IT Mole diamantate per levigatura
 GB Diamond grinding cup wheels
 ES Muelas de diamante para el pulido



| Art. | Ø | | Ø | |
|------------|-----|------|--------|--|
| | mm | inch | mm | |
| PUSC100M14 | 100 | 4 | M14 | |
| PUSC115 | 115 | 4,5 | 22,2 * | |
| PUSC125 | 125 | 5 | 22,2 * | |
| PUSC150 | 150 | 6 | 22,2 * | |
| PUSC180 | 180 | 7 | 22,2 * | |

* 5/8 inch: Riduzione a richiesta • Reduction on request • Reducción a pedido

Calcestruzzo/Materiali lapidei - Concrete/Stone materials
 Hormigón/Materiales pétreos

Art. AUM14



Adattatore 22,2mm / M14
 Adapter 22,2mm / M14
 Racor 22,2mm / M14

SECTOR

IT Mole diamantate per levigatura
 GB Diamond grinding cup wheels
 ES Muelas de diamante para el pulido



| Art. | Ø | | Ø | |
|---------|-----|------|--------|--|
| | mm | inch | mm | |
| PUSA115 | 115 | 4,5 | 22,2 * | |
| PUSA125 | 125 | 5 | 22,2 * | |
| PUSA180 | 180 | 7 | 22,2 * | |

* 5/8 inch: Riduzione a richiesta • Reduction on request • Reducción a pedido

Materiali abrasivi - Abrasive materials - Materiales abrasivos

Art. AUM14



Adattatore 22,2mm / M14
 Adapter 22,2mm / M14
 Racor 22,2mm / M14

DISPLAY

Art. 400P5C

pg. 4 **Prodotto**
→ **Product**
→ **Producto**



Art. 400FL3

pg. 28 **Prodotto**
→ **Product**
→ **Producto**



Art. 400BTL

pg. 34 **Prodotto**
→ **Product**
→ **Producto**



Art. 400CGX

pg. 61 **Prodotto**
→ **Product**
→ **Producto**



Art. 400FUXT

pg. 68 **Prodotto**
→ **Product**
→ **Producto**



Art. 400FAJEX

pg. 86 **Prodotto**
→ **Product**
→ **Producto**



Art. 400FT-S

pg. 91 **Prodotto**
→ **Product**
→ **Producto**



Art. 400FLEXI

pg. 103 **Prodotto**
→ **Product**
→ **Producto**



TOTEM

IT Espositori
GB Displays
ES Expositores



Art. 960DM

Art. 960M

Art. 960S



Art. 960G



Art.

| | | |
|-------|---|-------------------------------|
| 960M | Expo macchine ed utensili - <i>Expo machine & tools</i> - <i>Expo máquinas y herramientas</i> | 104x45x234 cm - 40x18x92-1/8" |
| 960DM | Expo utensili diamantati - <i>Expo diamond tools</i> - <i>Expo herramientas de diamante</i> | 104x45x234 cm - 40x18x92-1/8" |
| 960S | Serrature di sicurezza - <i>Security locks</i> - <i>Cerraduras de seguridad</i> | set 30 pcs. |
| 960G | Ganci doppi per pannello forato - <i>Double hooks for perforated panel</i> - <i>Ganchos dobles para tablero perforado</i> | set 10 pcs. |

TOTEM MASTERPIUMA







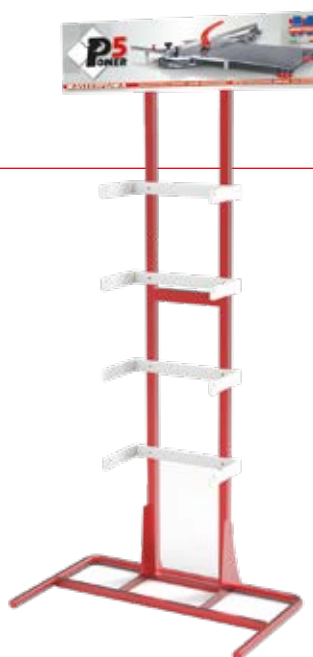































IT Espositore Masterpiuma
GB Masterpiuma display
ES Expositor Masterpiuma

Art.

960MP (79x60x203h cm - 31x23,5x78 inch)





SYMBOLOGIA • SYMBOLOGY • SIMBOLOGÍA

| | | | | | |
|---|--|---|---|---|---|
|  | Lunghezza massima di taglio Maximum cutting length Longitud máxima de corte |  | Attacco fresa Connection for cutter Conexión para fresa |  | Potenza motore Motor power Potencia del motor |
|  | Lunghezza di taglio in diagonale Diagonal cutting length Longitud de corte en diagonal |  | Attacco fresa Connection for cutter Conexión para fresa |  | Smerigliatrice angolare Electric angle grinder Lijadora angular |
|  | Spessore massimo di taglio Maximum cutting thickness Espesor máximo de corte |  | Attacco fresa Connection for cutter Conexión para fresa |  | Scanalatore Wall Chaser Rozadora |
|  | Potenza di spacco Power breaking Potencia de ruptura |  | Dimensioni Dimensions Dimensiones |  | Taglierina elettrica ad acqua Electric, water-cooled diamond tilesaw Cortadora eléctrica con agua |
|  | Peso Weight Peso |  | Altezza Height Altura |  | Taglierina elettrica ad acqua Electric, water-cooled diamond tilesaw Cortadora eléctrica con agua |
|  | Diametro fresa Cutter diameter Diámetro del cortador |  | Tipo o numero batterie Battery type or number Tipo o número de batería |  | Taglierina da cantiere Slitting saw cut-off machine Cortadora de mesa |
|  | Diametro e foro disco Blade and central bore diameter Diámetro y orificio del disco |  | Tempi di ricarica batterie Battery charging times Tiempos de carga de la batería |  | Troncatore Cutting-off machine Máquina cortadora |
|  | Attacco mola/platorello Connection for cup wheel Conexión para muela |  | Connettore USB USB connector Conector USB |  | Taglia pavimenti Floor cutting machine Corta pavimentos |
|  | Non ammesso l'uso della percussione Not permitted for use with percussion drill No permitido el uso de percusión |  | Portata Flow rate Caudal |  | Sistema motorizzato MOTOFLASH Motorized system MOTOFLASH Sistema motorizado MOTOFLASH |
|  | Numero di segmenti Number of segments Número de segmentos |  | Non ammesso l'uso a secco Not permitted for dry cutting-off No permitido el uso in seco |  | Elettroforatrice ad acqua Water type electrical drilling machine Perforadora eléctrica con agua |
|  | Spessore del disco Thickness of blade Espesor del disco |  | Utilizzo a secco Dry use Utilizar en seco |  | Trapano/Carotatrice manuale Power drill Perforadora manual |
|  | Imballo / Packing / Embalaje |  | Utilizzo a secco con aspirazione Dry use with aspiration Uso in seco con aspiración |  | Trapano a batteria Cordless drill Taladro inalámbrico |
| B = Blister C = Cartone/Carton/ Cartón S = Scatola/Box/Caja T = Sacchetto/Sack/Saco V = Non imballato/Not packed/Sin embalaje | Unità Unit Unidad |  | Utilizzo ad umido Wet use Utilizar en mojado |  | Carotatrice professionale a telaio Professional core drilling machine with frame Perforadora profesionales con soportes |



montolit.com

 Registrati sul nostro sito per ricevere news, informazioni tecniche e promozioni su tutti i nostri prodotti.

 *Subscribe on our website to receive news, technical information and promos on all our products.*

 *Suscribirse en nuestro sitio web para recibir información y promociones en todos nuestros productos.*

GARANZIA

MACCHINE ED ATTREZZATURE: per tutte le attrezzature MONTOLIT è riconosciuta una garanzia di 2 (due) anni a partire dalla data di vendita (fattura / bolla di consegna / scontrino fiscale). Tagliapiastrelle, forapiastrelle, tranciblocchi e tagliategole manuali sono coperti da garanzia a vita su eventuali difetti di costruzione (riconosciuti a giudizio esclusivo dell'Ufficio Tecnico della Brevetti MONTOLIT S.p.A.). Guasti derivanti da un uso non conforme o da normale usura sono esclusi dalle presenti garanzie.

UTENSILI DIAMANTATI: viene riconosciuta totalmente, a giudizio dell'Ufficio Tecnico della Brevetti MONTOLIT S.p.A., su dischi appena usati e non ancora consumati che presentino evidenti difetti di fabbricazione. La garanzia non verrà riconosciuta per i dischi deteriorati in seguito al loro uso per tagli di materiali diversi da quelli per i quali sono stati specificatamente prodotti. Reclami riguardanti qualsiasi disco da taglio consegnato saranno accettati solamente se il consumo dell'altezza della fascia diamantata non abbia superato il 20%.

Da sempre, la Brevetti MONTOLIT impiega e fornisce materiali di prima scelta. Si tratta di un impegno di serietà e moralità commerciale che eleva la Nostra Azienda al di sopra dello standard. Sicurezza e garanzia del prodotto costituiscono per noi motivo di vanto. Una realtà operativa che non è fatta solo di parole, ma anche di vere e proprie garanzie scritte. Infatti assicuriamo tutti i nostri prodotti contro i danni involontariamente cagionati in conseguenza di un fatto accidentale verificatosi per difetto di costruzione e fabbricazione del prodotto anche dopo la sua consegna e commercializzazione.

WARRANTY

MACHINES AND EQUIPMENT: all MONTOLIT tools are covered by a 2 (two) years warranty starting from the date of sale (proof provided by an invoice, delivery note or fiscal receipt). Manually operated tile cutters, tile drills, block cutters and roof tile cutters are covered by a lifetime warranty (claims allowed at the sole discretion of Brevetti MONTOLIT S.p.A. Engineering Department) in respect of construction defects. Defects resulting from improper use or from normal wear and tear are excluded from the terms of these warranties.

DIAMOND TOOLS: it is wholly acknowledged by Brevetti MONTOLIT S.p.A. Technical Office, for discs barely used and not yet worn out, which present clearly visible manufacturing defects. This guarantee does not cover discs used for cutting materials different from the ones they have been manufactured for. Complaints on any delivered diamond cutting discs will only be accepted if the wear of the rim height does not exceed 20%.

Brevetti MONTOLIT has always employed and supplied top quality materials and products. Our professional commitment to our customers places us well above the common standard. We take great pride in the safety and reliability of our products. Commitment to quality is not just an idle boast-our products are covered by full written warranties. In fact, we insure all our products against accidental damage due to manufacturing defects and poor workmanship after sale and delivery.

GARANZIA

MÁQUINAS Y EQUIPOS: para todos los equipos MONTOLIT se reconoce una garantía de 2 (dos) años a partir de la fecha de venta (factura / justificante de entrega/ticket de compra). Las cortadoras de baldosas, perforadoras de baldosas, cortadoras de bloques y cortadoras de tejas manuales están cubiertas por una garantía de por vida sobre defectos de fabricación (reconocidos solamente por juicio exclusivo por el Servicio Técnico de la Firma MONTOLIT S.p.A). Problemas derivados de un uso inadecuado o por un uso normal se excluyen de las garantías presentes.

HERRAMIENTAS DIAMANTADORAS: es reconocida totalmente, a juicio del Servicio Técnico de la Firma MONTOLIT S.p.A, sobre discos apenas utilizados y aún no consumidos que presenten evidentes problemas de fabricación. La garantía no será reconocida para aquellos discos que estén deteriorados a causa de su uso para cortar materiales diversos a aquellos de los cuáles para los que han sido concretamente fabricados. Aquellas reclamaciones que relacionen a cualquier disco de corte serán aceptados solamente si el desgaste de la altura de la franja diamantada no ha superado el 20%.

Desde siempre, la Firma MONTOLIT utiliza y entrega materiales de primera calidad. Se trata de un empeño de seriedad y moralidad comercial que eleva a Nuestra Empresa por encima de los estándares de calidad. La seguridad y la garantía del producto constituyen para nosotros un motivo de orgullo. Una realidad operativa que no está constituida solamente de palabras, pero también de verdaderas y reales garantías escritas. Aseguramos todos nuestros productos contra daños involuntarios a causa de un accidente provocado a causa de defectos de construcción y fabricación del producto después de su entrega y comercialización.



1946

Brevetti Montolit S.p.A.

Sedi operative | *Company headquarters* | *Sede de la empresa:*

Largo Cav. Montoli - 21050 Cantello (VA) Italy

Via Varese 4/A - 21050 Cantello (VA) Italy

Sede legale | *Legal head office* | *Sede legal:*

Via Turconi, 25 - 21050 Cantello (VA) Italy

Tel. ++39 0332 419 211

Fax ++39 0332 418 444

info@montolit.com

SERVIZIO CLIENTI / CUSTOMER SERVICE



service@montolit.com

Per consigli e soluzioni tecniche
For advice and technical solutions
Para asesoramiento y soluciones técnicas

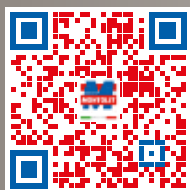

montolit.com



Montolit è partner tecnico delle seguenti scuole e associazioni:
Montolit is a technical partner of the following schools and associations:
Montolit es socio técnico de las siguientes escuelas y asociaciones:

Associata con: | *Associated with:* | *Asociado con:*



Rivenditore autorizzato | *Authorised dealer* | *Distribuidor autorizado:*



Descrizioni ed illustrazioni si intendono fornite a semplice titolo indicativo. La Casa si riserva il diritto, ferme restando le caratteristiche essenziali dei modelli qui descritti ed illustrati, di apportare ai propri prodotti, in qualunque momento, e senza preavviso, le eventuali modifiche da essa ritenute necessarie a scopo di miglioramento o per qualsiasi esigenza di carattere costruttivo o commerciale.

Descriptions and illustrations are purely indicative. Without prejudice to the essential features of the models described and illustrated herein, the Company reserves all rights of marking product changes and without notice at any moment considered necessary for improvement of required in the interest of product engineering and sale.

Las descripciones y las ilustraciones son entregadas como simple título indicativo. La Casa fabricante se reserva el derecho, de mantener las características esenciales de los modelos aquí descritas e ilustrados, y de aportar a sus mismos productos, en cualquier momento, y sin aviso previo, modificaciones consideradas necesarias para su mejora o para cualquier exigencia de carácter constructivo o comercial.